



3-8550.090-2 Rev. L 10/11 English



## WARNING!

- Remove power to unit before wiring input and output connections.
- Follow instructions carefully to avoid personal injury.

## Contents

1. Specifications
2. Installation
3. Electrical Connections
4. Menu Functions



## 1. Specifications

### Dimensions

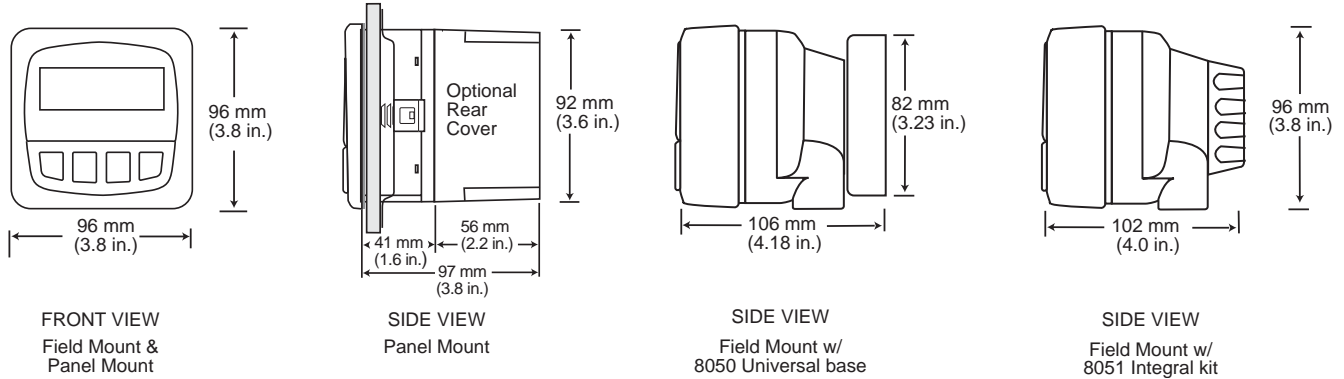

### General

- Compatibility:** Signet Flow Sensors (w/freq out)
- Enclosure:**
- Case: PBT
  - Panel case gasket: Neoprene
  - Window: Polyurethane coated polycarbonate
  - Keypad: Sealed 4-key silicone rubber
  - Weight: Approx. 325 g (12 oz.)

### Display:

- Alphanumeric 2 x 16 LCD
- Update rate: 1 second
- Contrast: User selected, 5 levels
- Accuracy:  $\pm 0.5\%$  of reading @25 °C
- Thermal sensitivity shift:  $\pm 0.005\%$  of reading per °C

### Electrical

- Power: 12 to 24 VDC  $\pm 10\%$ , regulated, 220 mA max current
- Sensor Input:**
- Range: 0.5 to 1500 Hz
  - Sensor power: 2-wire: 1.5 mA @ 5 VDC  $\pm 1\%$   
3 or 4 wire: 20 mA @ 5 VDC  $\pm 1\%$
  - Optically isolated from current loop
  - Short circuit protected

### Current output:

- 4 to 20 mA, isolated, fully adjustable and reversible
- Max loop impedance: 50  $\Omega$  max. @ 12 V  
325  $\Omega$  max. @ 18 V  
600  $\Omega$  max. @ 24 V
- Update rate: 100 ms
- Accuracy:  $\pm 0.03$  mA

### Relay outputs (2 sets mechanical SPDT contacts):

- Maximum voltage rating: 5 A @ 30 VDC, or 5 A @ 250 VAC, resistive load
- Programmable for:
  - High or Low setpoint with adjustable hysteresis
  - Pulse proportional to volume (max 300 pulses/minute)

### Environmental

- Operating temperature: -10 to 70 °C (14 to 158 °F)
- Storage temperature: -15 to 80 °C (5 to 176 °F)
- Relative humidity: 0 to 95%, non-condensing
- Maximum altitude: 2000 m (6562 ft)
- Insulation category: II
- Pollution degree: 2
- Rating: NEMA 4X/IP65 front

### Standards and Approvals

- CE, UL listed
- Immunity and Emissions: EN61326
- Manufactured under ISO 9001 and ISO 14001

China RoHS (Go to [www.gfsignet.com](http://www.gfsignet.com) for details)

## 2. Installation

ProcessPro transmitters are available in two styles: panel mount and field mount. The panel mount is supplied with the necessary hardware to install the transmitter. This manual includes complete panel mounting instructions.

Field mounting requires one of two separate mounting kits. The 3-8051 integral kit joins the sensor and instrument together into a single package. The 3-8050 Universal kit enables the transmitter to be installed virtually anywhere.

Detailed instructions for integral mounting or other field installation options are included with the 3-8051 Integral kit or the 3-8050 Universal kit.

## 2.1 Panel Installation

1. The panel mount transmitter is designed for installation using a 1/4 DIN Punch. For manual panel cutout, an adhesive template is provided as an installation guide. Recommended clearance on all sides between instruments is 1 inch.
2. Place gasket on instrument, and install in panel.
3. Slide mounting bracket over back of instrument until quick-clips snap into latches on side of instrument.
4. To remove, secure instrument temporarily with tape from front or grip from rear of instrument. DO NOT RELEASE. Press quick-clips outward and remove.

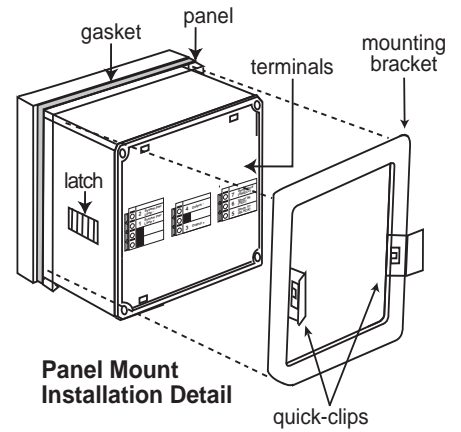

## 3. Electrical Connections



**CAUTION:** Failure to fully open terminal jaws before removing wire may permanently damage instrument.

### Wiring Procedure

1. Remove 0.5 - 0.625 in. (13-16 mm) of insulation from wire end.
2. Press the orange terminal lever downward with a small screwdriver to open terminal jaws.
3. Insert exposed (non-insulated) wire end in terminal hole until it bottoms out.
4. Release orange terminal lever to secure wire in place. Gently pull on each wire to ensure a good connection.



### Wiring Removal Procedure

1. Press the orange terminal lever downward with a small screwdriver to open terminal jaws.
2. When fully open, remove wire from terminal.

**Terminals 3 and 4: Loop Power**  
 12-24 VDC  $\pm 10\%$  system power and current loop output.  
 Max. loop impedance:  
 50  $\Omega$  max. @ 12 V  
 325  $\Omega$  max. @ 18 V  
 600  $\Omega$  max. @ 24 V

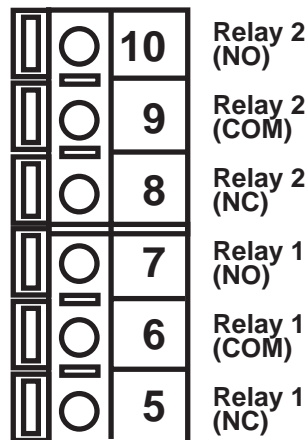
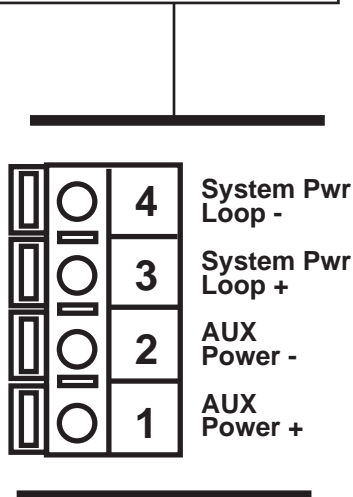

**Terminals 11-13: Flow sensor input**

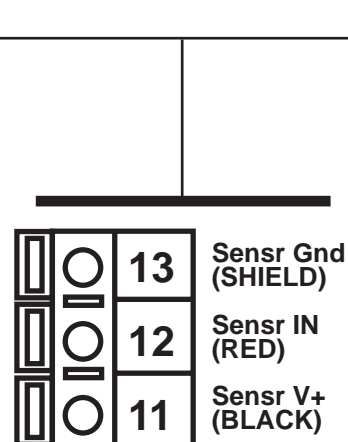

**Terminals 1 and 2: AUXILIARY power**  
 Used only if the flow sensor requires more than 1.5 mA current. For Signet sensors this is limited to the following products:  
 • 2000 • 2507 • 2551 • 2552  
 • Open-collector Input signals

**Terminals 5-10: Relay Outputs**  
 Two sets mechanical SPDT contacts, programmable (see CALIBRATE menu) as:  
 • High or Low setpoint with adjustable hysteresis  
 • Volumetric pulse based on totalizer  
 • May be disabled (Off) if not used.

### 3.1 System Power/Loop Connections

Stand-alone application, no current loop used

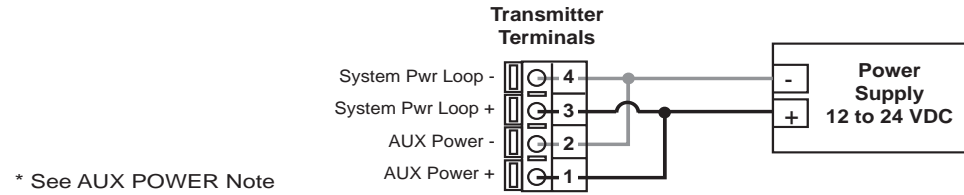

Connection to a PLC/Recorder, separate supply

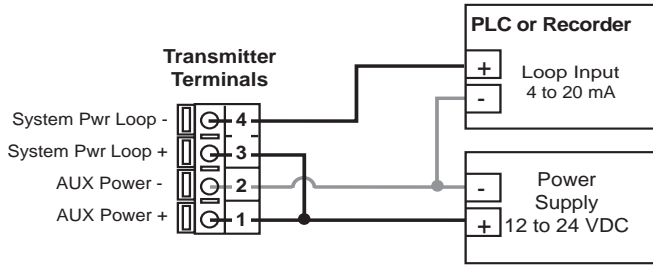

Connection to a PLC with built-in power supply

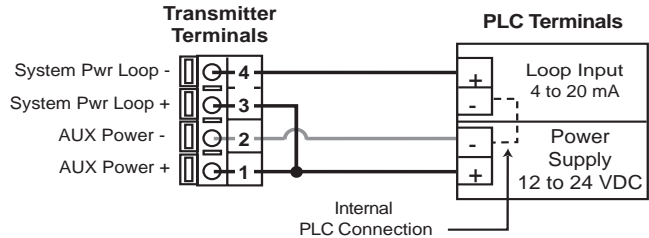

Example: Two transmitters connected to PLC/Recorder with separate power supply

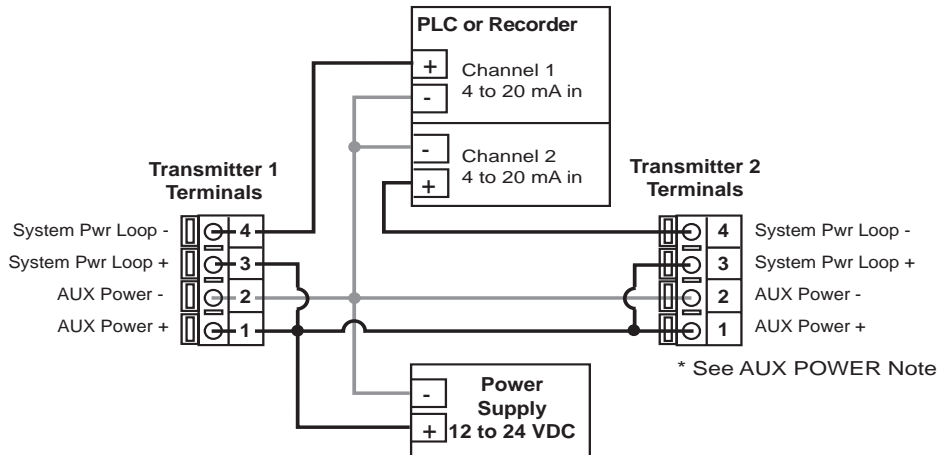

#### Auxiliary Power note:

AUXILIARY power is required for all systems where relays are used.

### 3.2 Sensor Input Connections

#### Wiring Tips:

- Do not route sensor cable in conduit containing AC power wiring. Electrical noise may interfere with sensor signal.
- Routing sensor cable in grounded metal conduit will help prevent electrical noise and mechanical damage.
- Seal cable entry points to prevent moisture damage.
- Only one wire should be inserted into a terminal. Splice double wires outside the terminal.

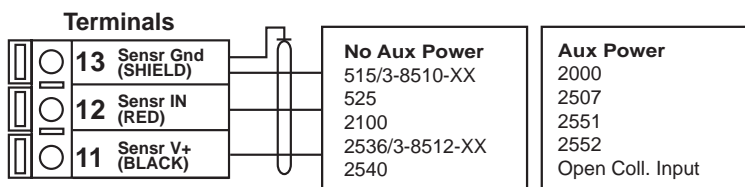

Maximum cable length is 200 ft for 515/8510-XX, 525 and any sinusoidal flow signal.

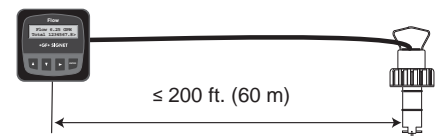

Maximum cable length is 1000 ft for 2536/8512-XX, 2537, 2540 and any open collector flow signal.

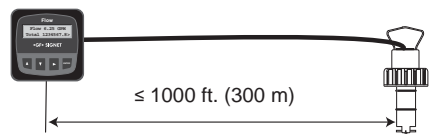

### 3.3 Relay Output

The relay outputs can be programmed to respond when the flow rate moves above or below a setpoint, or they can be used to generate a pulse that is relative to the flow volume. The relays can be disabled if not in use.

- **Low**

Relay energizes when the flow rate is less than the setpoint. The relay de-energizes when the flow rate moves above the setpoint plus the hysteresis value.



- **High**

Relay energizes when the flow rate is greater than the setpoint. The relay will de-energize when the flow rate drops below the setpoint plus the hysteresis value.

- **Pulse**

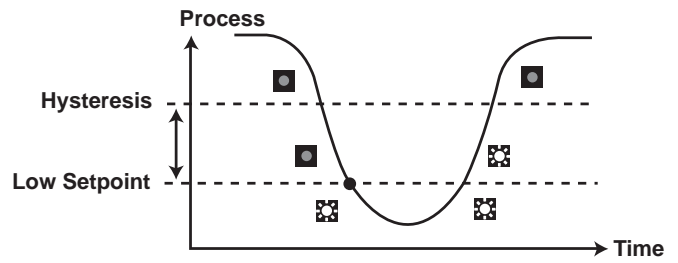
Relay output is a pulse based on the volume of fluid that passes the sensor. Set any value from 0.0001 to 99999.



Relay energized   
Relay de-energized 

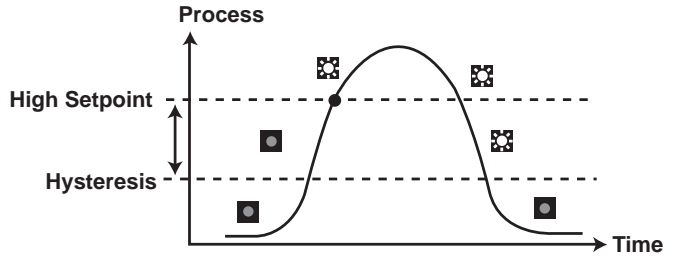

## VIEW menu

- During normal operation, the ProcessPro displays the VIEW menu.
- When using the CALIBRATE or OPTIONS menus, the ProcessPro will return to the VIEW menu if no activity occurs for 10 minutes.
- To select the item you want displayed, press the UP or DOWN arrow keys. The items will scroll in a continuous loop. Changing the display selection does not interrupt system operations.
- No key code is necessary to change display selection.
- Output settings cannot be edited from the VIEW menu.



### View Menu

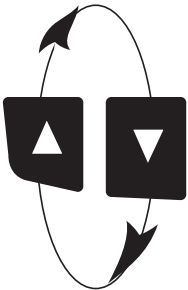

Display	Description
0.0 GPM Total: 12345678 >	Monitor the flow rate and the resettable totalizer. Press ► to reset the totalizer. If the Reset is locked, enter the Key Code first. Lock or Unlock the totalizer in the OPTIONS menu. This is the permanent View display.
<b>All of the displays below are temporary. After 10 minutes the display returns to the permanent display.</b>	
Perm: 12345678 Gallons	Monitor the Permanent Totalizer value.
Loop Output: 12.00 mA	Monitor the 4 to 20 mA Loop output.
Last CAL: 02-10-09	Monitor date for scheduled maintenance or date of last calibration. (See description in Calibrate Menu.)

# ProcessPro Editing Procedure:

## Step 1. Press and hold ENTER key:

- 2 seconds to select the CALIBRATE menu
- 5 seconds to select the OPTIONS menu.

## Step 2. The Key Code is UP-UP-UP-DOWN keys in sequence.

- After entering the Key Code, the display will show the first item in the selected menu.

## Step 3. Scroll menu with UP or DOWN arrow keys.

## Step 4. Press RIGHT ARROW key to select menu item to be edited.

- The first display element will begin flashing.

## Step 5. Press UP or DOWN keys to edit the flashing element.

- RIGHT ARROW key advances the flashing element.

## Step 6. Press ENTER key to save the new setting and return to Step 3.

### Notes on Step 1:

- The View Menu is normally displayed.
- The CALIBRATE and OPTIONS menus require a KEY CODE.

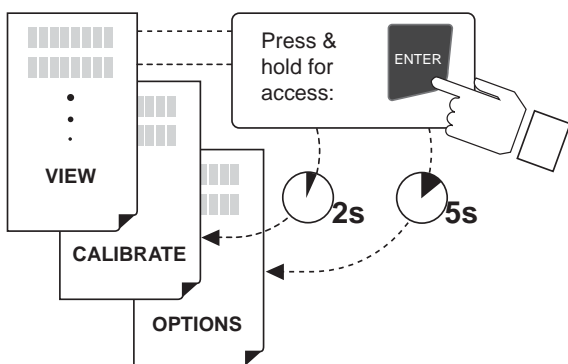

### Notes on Step 2:

If no key is pressed for 5 minutes while display is showing "Enter Key Code", the display will return to the VIEW menu.

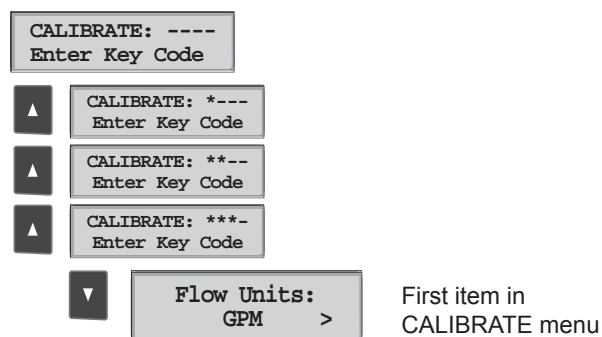

### Notes on Steps 3 and 4:

- Refer to pages 6 and 7 for complete listing of menu items and their use.
- From the Step 3 display, pressing the UP and DOWN keys simultaneously will return the display to the VIEW menu.
- If no key is pressed for 10 minutes, display will also return to the VIEW menu.

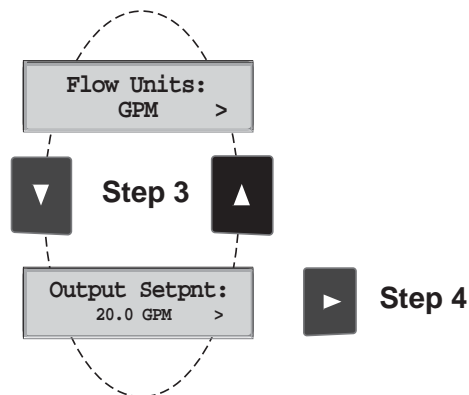

### Step 3: Finished Editing?

Press the UP and DOWN keys simultaneously after saving the last setting to return to normal operation.

### Notes on Steps 5 and 6:

- All output functions remain active during editing.
- Only the flashing element can be edited.
- RIGHT ARROW key advances the flashing element in a continuous loop.
- Edited value is effective immediately after pressing ENTER key.
- If no key is pressed for 10 minutes unit will restore the last saved value and return to step 3.
- Step 6 (pressing ENTER key) always returns you to Step 3.
- Repeat steps 3-6 until all editing is completed.

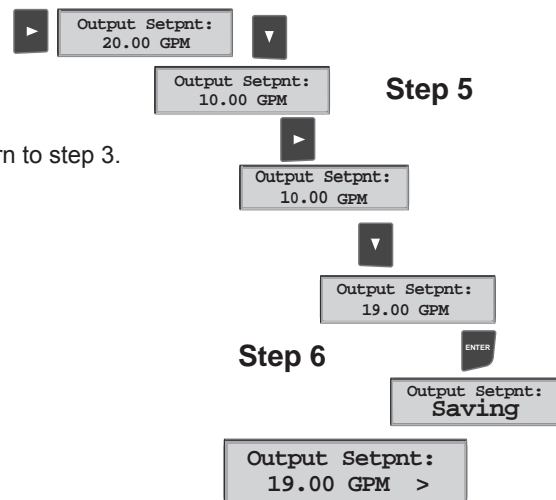

### Step 5: Made an Error?

Press the UP and DOWN keys simultaneously while any element is flashing. This will recall the last saved value of the item being edited and return you to Step 3.



## Calibrate Menu

Display (Factory settings shown)	Description
<b>Flow Units:</b> <b>GPM</b> >	The first three characters set the Flow Rate units of measure and have no effect on calculations. They may be any character, upper or lower case. The last character sets the Flow rate Timebase. Select S (seconds), M (minutes), H (hours) or D (days)
<b>Flow K-Factor:</b> <b>60</b>	This setting converts the input frequency from the flow sensor into a flow rate. The K-Factor is unique to the sensor model and to the pipe size and schedule. Refer to data in the sensor manual for the correct value. Limits: 0.0001 to 99999. (The K-factor cannot be set to 0.)
<b>Total Units:</b> <b>Gallons</b>	This setting identifies the Totalizer units. It has no effect on any calculation. It serves as a label only. Each character can be any alpha or numeric selection, upper or lower case.
<b>Total K-Factor</b> <b>60.0000</b> >	This setting converts the input frequency from the flow sensor into a volumetric total. It is also used as the basis for the Open Collector pulse mode. The setting is usually the same as the Flow K-Factor, or different by x10 or x100. Limits: 0.0001 to 99999. (Cannot be set to 0.)
<b>Loop Range: GPM</b> <b>000.00 → 100.00</b> >	Select the minimum and maximum values for the 4-20 mA Current loop output. The 8550 will allow any values from 0.0000 to 99999.
<b>Relay1 Mode:</b> <b>Low</b> >	Select the desired mode of operation for Relay 1. Options available are High, Low or volumetric Pulse. The signal may be disabled (Off) if not used.
<b>Relay1 Setpnt:</b> <b>10.000 GPM</b> >	In Low or High Mode, Relay 1 will be energized when the Flow rate reaches this value. Be sure to modify this setting if you change the Flow Units.
<b>Relay1 Hys:</b> <b>5.0000 GPM</b> >	Relay 1 will be de-energized at Setpoint ± Hysteresis, depending on High or Low Setpoint selection. (See details on page 4.)
<b>Relay1 Volume:</b> <b>100.00 Gallons</b> >	In Pulse mode, Relay 1 will generate one pulse when this volume of flow passes the sensor. The measurement is based on the Total K-Factor. The 8550 will allow any value from 0.0001 to 99999.
<b>Relay1 PlsWdth:</b> <b>0.1 Seconds</b> >	In Pulse mode, this setting defines the duration of the Relay pulse. The 8550 allows any value from 0.1 seconds to 999.9 seconds.
<b>Last CAL:</b> <b>2-10-09</b>	Use this "note pad" to record important dates, such as annual recertification or scheduled maintenance.

All Relay settings repeat for Relay 2.

## Options Menu

Display (Factory settings shown)	Description
<b>Contrast:</b>  3>	Adjust the LCD contrast for best viewing. A setting of 1 is lowest contrast, 5 is highest. Select lower contrast if the display is in warmer ambient surroundings.
<b>Flow Decimal</b>  *****. >	Set the decimal to the best resolution for your application. The display will automatically scale up to this resolution. Select *****., ******, ******, **.*** or *.*****
<b>Total Decimal</b>  *****.** >	Set the totalizer decimal to the best resolution for your application. Select *****., ******, or *****.**
<b>Averaging</b>  Off >	OFF provides the quickest output response to changes in flow. Longer averaging period produces more stable display and output response. Select OFF, 8 s, 20 s, 50 s or 120 s.
<b>Sensitivity</b>  0 >	Sensitivity works in conjunction with Averaging to balance response time with signal stability. Selections are 0 to 9. Select 0 (zero) for the minimum sensitivity, or 9 for the maximum sensitivity. The function is described below.
<b>Total Reset</b>  Lock Off >	Lock Off : No key code required to reset the resettable totalizer. Lock On : The Key Code must be entered to reset the resettable totalizer.
<b>Loop Adjust</b>  4.00 mA >	Adjust the minimum and maximum current output. Use this setting to match the system output to any external device. The display value represents the precise current output. Adjustment limits: • 3.80 mA < 4.00 mA > 5.00 mA • 19.00 mA < 20.00 mA > 21.00 mA
<b>Loop Adjust</b>  20.00 mA >	
<b>Test Loop</b>  >	Press UP or DOWN keys to manually order any output current value from 3.6 mA to 21.00 mA to test current loop output.
<b>Test Relay 1</b>  >	Press UP or DOWN keys to manually toggle the state of relay 1. Repeat for relay 2.

### ■ ■ ■ ■ ■ No AVERAGING, no SENSITIVITY

With AVERAGING set to 0 (zero) and with SENSITIVITY set to zero, the 8550 responds to every unstable shift in the flow. The dashed red line represents the actual output of the flow sensor in unstable flow conditions .

### ..... AVERAGING only

With AVERAGING set to 50 seconds and SENSITIVITY still set to zero the flow rate is stabilized, but a sharp change in flow rate is not represented for 50 seconds or longer. (dotted green line).

### ———— AVERAGING and SENSITIVITY

With AVERAGING at 50 seconds and SENSITIVITY set to 4 OR 5, the flow rate is stabilized, while the sudden shift in flow is reflected very quickly. (Solid blue line)

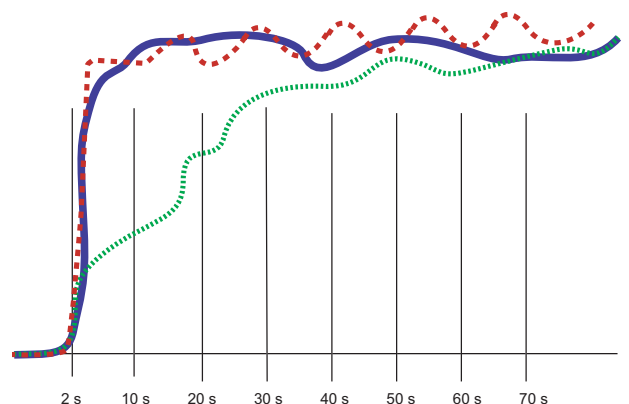

**NOTE:** The SENSITIVITY function is ineffective if the AVERAGING function is set to zero (seconds).

## Troubleshooting

Display Condition	Possible Causes	Suggested Solutions
- - - - -	Flow rate exceeds display capability	<ul style="list-style-type: none"> <li>• Increase Flow units time base</li> <li>• Move flow decimal one place to the right</li> </ul>
Pulse Overrun	<ul style="list-style-type: none"> <li>• Relay pulse rate exceeds maximum of 300 pulses per minute.</li> <li>• Pulse width set too wide.</li> </ul>	<ul style="list-style-type: none"> <li>• Increase Pulse volume setting</li> <li>• Decrease pulse width setting.</li> <li>• Reduce system flow rate</li> </ul>
Value must be more than 0	K-Factors cannot be set to 0.	Enter K-Factor from 0.0001 to 99999
Open Collector is always activated	<ul style="list-style-type: none"> <li>• Hysteresis value too large</li> <li>• Defective transmitter</li> </ul>	<ul style="list-style-type: none"> <li>• Change the hysteresis value</li> <li>• Replace transmitter</li> </ul>

## Ordering Information

Mfr. Part No.	Code	Description
3-8550-1	159 000 047	Flow transmitter, Field mount
3-8550-1P	159 000 048	Flow transmitter, Panel mount
3-8550-2	159 000 049	Flow transmitter, Field mount with relays
3-8550-2P	159 000 050	Flow transmitter, Panel mount with relays
3-8550-3	159 000 051	Flow transmitter, Field mount with dual input/output
3-8550-3P	159 000 052	Flow transmitter, Panel mount with dual input/output

### Accessories

Mfr. Part No.	Code	Description
3-8050	159 000 184	Universal mounting kit
3-8051	159 000 187	Flow Integral Mnt NPT
3-8050.395	159 000 186	Splashproof rear cover
3-8050.396	159 000 617	RC Filter kit (for relay use)
3-0000.596	159 000 641	Heavy duty wall mount bracket
3-5000.598	198 840 225	Surface Mount Bracket
3-5000.399	198 840 224	5 x 5 inch adapter plate for Signet retrofit
3-9000.392	159 000 368	Liquid tight connector kit for rear cover (includes 3 connectors)
3-9000.392-1	159 000 839	Liquid tight connector kit, NPT (1 piece)
3-9000.392-2	159 000 841	Liquid tight connector kit, PG13.5 (1 piece)
7300-7524	159 000 687	24 VDC Power Supply 7.5 W, 300 mA
7300-1524	159 000 688	24 VDC Power Supply 15 W, 600 mA
7300-3024	159 000 689	24 VDC Power Supply 30 W, 1.3 A
7300-5024	159 000 690	24 VDC Power Supply 50 W, 2.1 A
7300-1024	159 000 691	24 VDC Power Supply 100 W, 4.2 A



Georg Fischer Signet LLC, 3401 Aerojet Avenue, El Monte, CA 91731-2882 U.S.A. • Tel. (626) 571-2770 • Fax (626) 573-2057  
 For Worldwide Sales and Service, visit our website: [www.gfsignet.com](http://www.gfsignet.com) • Or call (in the U.S.): (800) 854-4090  
 For the most up-to-date information, please refer to our website at [www.gfsignet.com](http://www.gfsignet.com)