



3-8550.090-3 Rev. L 10/11 English



WARNING!

- Remove power to unit before wiring input and output connections.
- Follow instructions carefully to avoid personal injury.

Contents

1. Specifications
2. Installation
3. Electrical Connections
4. Menu Functions

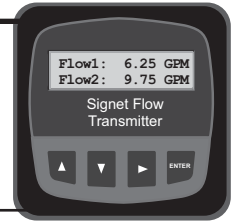

1. Specifications

Dimensions

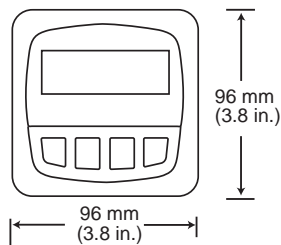

FRONT VIEW
Field Mount & Panel Mount

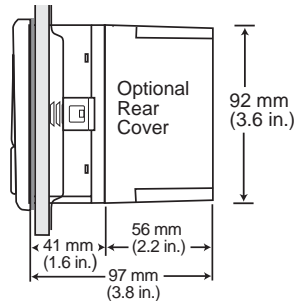

SIDE VIEW
Panel Mount

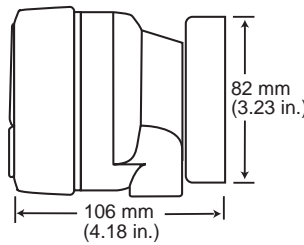

SIDE VIEW
Field Mount w/
8050 Universal base

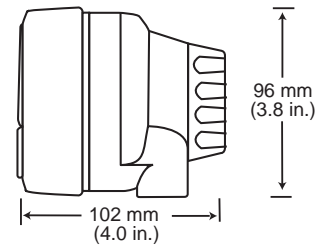

SIDE VIEW
Field Mount w/
8051 Integral kit

General

Compatibility: Signet Flow Sensors (w/freq out)

Enclosure:

- Case: PBT
- Panel case gasket: Neoprene
- Window: Polyurethane coated polycarbonate
- Keypad: Sealed 4-key silicone rubber
- Weight: Approx. 325 g (12 oz.)

Display:

- Alphanumeric: 2 x 16 LCD
- Update rate: 1 second
- Contrast: User selected, 5 levels
- Accuracy: $\pm 0.5\%$ of reading @ 25 °C
- Thermal sensitivity shift: $\pm 0.005\%$ of reading per °C

Electrical

- Power: 12 to 24 VDC $\pm 10\%$, regulated, 100 mA max.

Sensor Inputs:

- Range: 0.5 to 1500 Hz
- Sensor power: 2-wire: 0.5 mA @ 5 VDC $\pm 1\%$
3- or 4-wire: 20 mA @ 5 VDC $\pm 1\%$
- Optically isolated from current loop
- Short circuit protected

Current output:

- 4 to 20 mA, isolated, fully adjustable and reversible
- Max loop impedance: 50 Ω max. @ 12 V
325 Ω max. @ 18 V
600 Ω max. @ 24 V
- Update rate: 100 ms
- Accuracy: ± 0.03 mA

Open-collector outputs, optically isolated:

- 50 mA max. sink, 30 VDC maximum pull-up voltage.
- Programmable for:
 - High or Low setpoint with adjustable hysteresis
 - Pulse proportional to rate or volume (max 300 pulses/min).

Environmental

- Operating temperature: -10 to 70 °C (14 to 158 °F)
- Storage temperature: -15 to 80 °C (5 to 176 °F)
- Relative humidity: 0 to 95%, non-condensing
- Maximum altitude: 2000 m (6562 ft)
- Insulation category: II
- Pollution degree: 2
- Rating: NEMA 4X/IP65 front

Standards and Approvals:

- CE, UL listed
- Immunity & Emissions: EN61326
- Manufactured under ISO 9001 and ISO 14001

China RoHS (Go to www.gfsignet.com for details)

2. Installation

ProcessPro transmitters are available in two styles: panel mount and field mount. The panel mount is supplied with the necessary hardware to install the transmitter. This manual includes complete panel mounting instructions.

Field mounting requires one of two separate mounting kits. The 3-8051 integral kit joins the sensor and instrument together into a single package. The 3-8050 Universal kit enables the transmitter to be installed virtually anywhere.

Detailed instructions for integral mounting or other field installation options are included with the 3-8051 Integral kit or the 3-8050 Universal kit.

2.1 Panel Installation

1. The panel mount transmitter is designed for installation using a 1/4 DIN Punch. For manual panel cutout, an adhesive template is provided as an installation guide. Recommended clearance on all sides between instruments is 1 inch.
2. Place gasket on instrument, and install in panel.
3. Slide mounting bracket over back of instrument until quick-clips snap into latches on side of instrument.
4. To remove, secure instrument temporarily with tape from front or grip from rear of instrument. DO NOT RELEASE. Press quick-clips outward and remove.

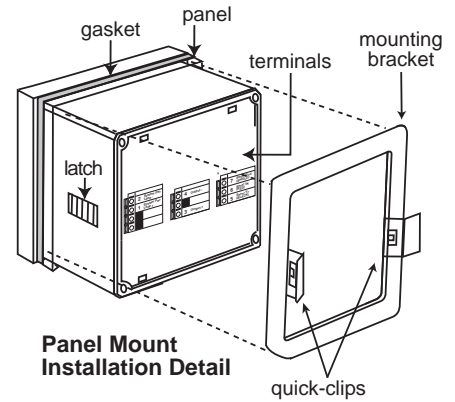

3. Electrical Connections



Caution: Failure to fully open terminal jaws before removing wire may permanently damage instrument.

Wiring Procedure

1. Remove 0.5 - 0.625 in. (13-16 mm) of insulation from wire end.
2. Press the orange terminal lever downward with a small screwdriver to open terminal jaws.
3. Insert exposed (non-insulated) wire end in terminal hole until it bottoms out.
4. Release orange terminal lever to secure wire in place. Gently pull on each wire to ensure a good connection.



Wiring Removal Procedure

1. Press the orange terminal lever downward with a small screwdriver to open terminal jaws.
2. When fully open, remove wire from terminal.

Terminals 3-6: Loop Power

12-24 VDC $\pm 10\%$ system power and current loop outputs.

Max. loop impedance:
 50 Ω max. @ 12 V
 325 Ω max. @ 18 V
 600 Ω max. @ 24 V

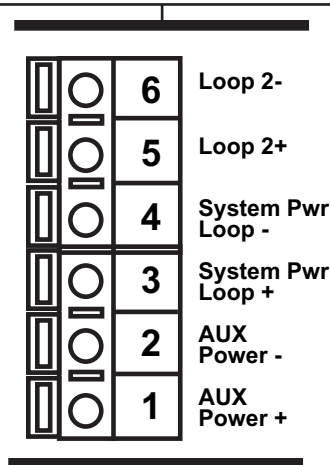

Terminals 11-16: Flow sensor inputs

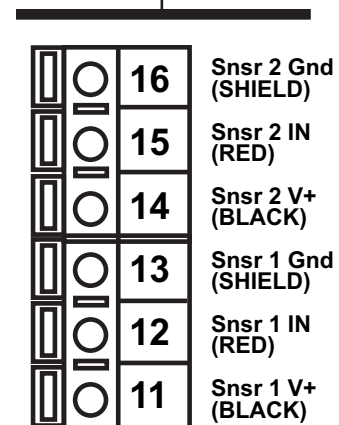

Terminals 1 and 2: AUXILIARY power

Used only if the flow sensor requires more than 1.5 mA current. For Signet sensors this is limited to the following products:
 • 2000 • 2507 • 2551 • 2552
 • Open-collector Input signals

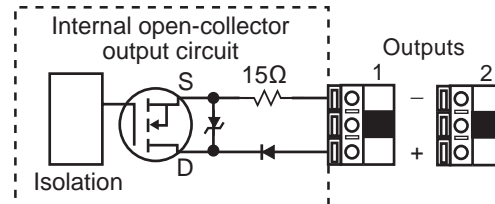

Terminals 7-10: Open-collector Outputs

Two transistor outputs, programmable (see CALIBRATE menu) as:

- High or Low setpoint with adjustable hysteresis.
- Pulse based on Volume.
- Frequency based on flow rate.

May be disabled (Off) if not used.

3.1 System Power/Loop Connections

Stand-alone application, no current loop used

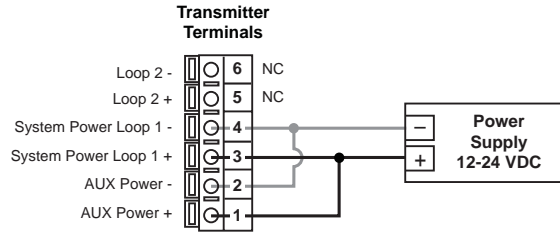

Connection to a PLC/Recorder, separate supply

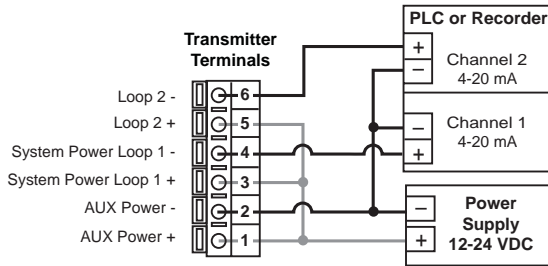

Connection to a PLC with built-in power supply

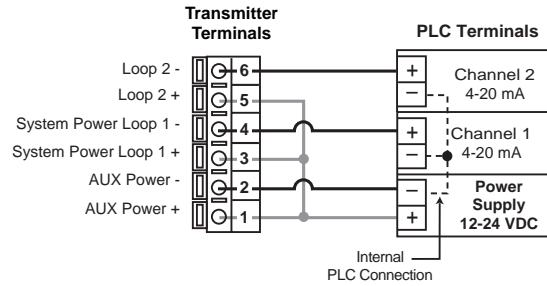

Example: Two transmitters connected to PLC/Recorder with separate power supply

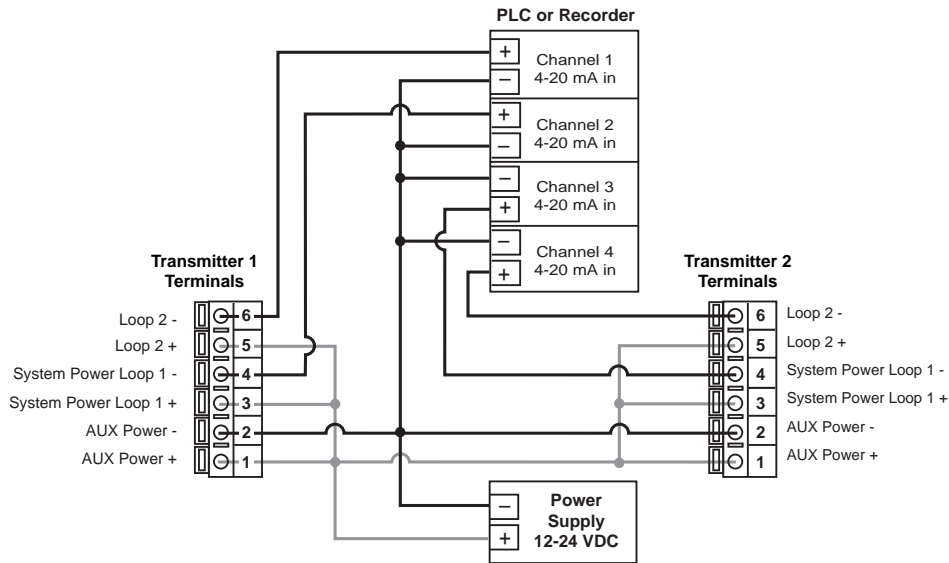

Auxiliary Power Note:

Auxiliary power is necessary for flow sensors that require more than 1.5 mA of current.

This includes the following Signet flow sensors: 2000, 2507, 2551, 2552 and all Open Collector signal inputs.

3.2 Sensor Input Connections

Wiring Tips:

- Do not route sensor cable in conduit containing AC power wiring. Electrical noise may interfere with sensor signal.
- Routing sensor cable in grounded metal conduit will help prevent electrical noise and mechanical damage.
- Seal cable entry points to prevent moisture damage.
- Only one wire should be inserted into a terminal. Splice double wires outside the terminal.

Maximum cable length is 60 m (200 ft.) for 515/8510-XX, 525 and any sinusoidal flow signal.

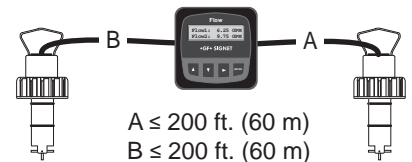

Terminals	No Aux Power	Aux Power Required
16 Snsr 2 Gnd (SHIELD)	515/3-8510-XX	2000
15 Snsr 2 IN (RED)	525	2507
14 Snsr 2 V+ (BLACK)	2100	2551
13 Snsr 1 Gnd (SHIELD)	2536/3-8512-XX	2552
12 Snsr 1 IN (RED)	2540/2541	Open-collector input signals
11 Snsr 1 V+ (BLACK)		

Maximum cable length is 305 m (1000 ft.) for 2536/8512-XX, 2540/2541 and any open-collector flow signal.

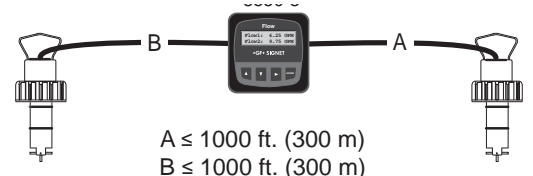

3.3 Open Collector Output

The Open collector output can be used as a switch that responds when the flow rate moves above or below a setpoint, or it can be used to generate a pulse that is relative to the flow volume or to the flow rate.

- **Low**

Output energizes when the flow rate is less than the setpoint. The output will de-energize when the flow rate moves above the setpoint plus the hysteresis value.

- **High**

Output energizes when the flow rate is greater than the setpoint. The output will de-energize when the flow rate drops below the setpoint plus the hysteresis value.

- **Frequency**



Output is a pulse stream that is based on the input flow sensor signal. Set for 1 (input frequency = output frequency). Set for even numbers (2, 4, 6, 8, 254 maximum) to scale output frequency.

- **Pulse**

Output is a pulse based on the volume of fluid that passes the sensor. Set any value from 0.0001 to 99999.

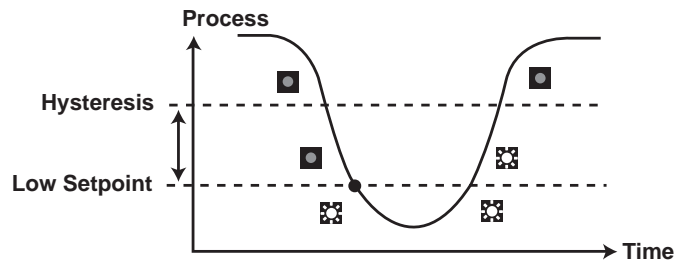
The output may be disabled (Off) if not used.



Relay energized 
Relay de-energized 

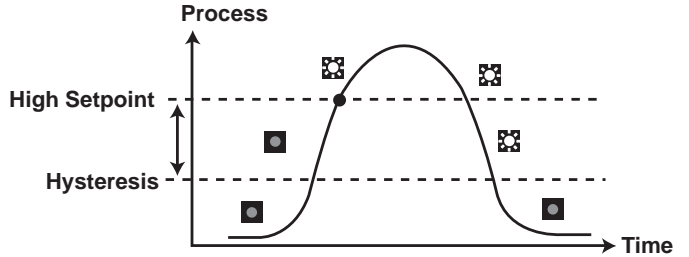

VIEW menu

- During normal operation, ProcessPro displays the VIEW menu.
- When editing the CALIBRATE or OPTIONS menus, ProcessPro will return to the VIEW menu if no activity occurs for 10 minutes.
- To select a VIEW display, press the UP or DOWN arrow keys. The selections will scroll in a continuous loop.
- Changing the VIEW display does not interrupt system operations.
- No key code is necessary to change display selection.
- Output settings cannot be edited from the VIEW menu.



View Menu

Display	Description
Flow1: 123.4 GPM Flow2: 567.8 GPM	Monitor the flow rate of Channel 1 and Channel 2 simultaneously. This is the permanent view display.
Delta Flow: 10.5 GPM	Monitor the delta flow rate (Channel 1 rate - channel 2 rate = Delta Flow) This is a permanent display.
All of the displays below are temporary. After 10 minutes the display returns to the permanent display.	
Tot1: 1234567.8 Tot2: 123456.78	Monitor channel 1 and channel 2 Resettable Totalizers. Press the RIGHT ARROW key to reset the totalizer. If Reset is locked, you must enter Key Code. Lock or Unlock function is in OPTIONS menu
Perm1: 1234567.8 Gallons	Monitor channel 1 Permanent Totalizer value.
Perm2: 123456.78 Gallons	Monitor channel 2 Permanent Totalizer value.
Loop 1 Output: 12.00 mA	Monitor the 4 to 20 mA output for Loop 1 and 2.
Loop 2 Output: 12.00 mA	
Last CAL: 02-10-09	Monitor date for scheduled maintenance or date of last calibration. (See description in Calibrate Menu.)

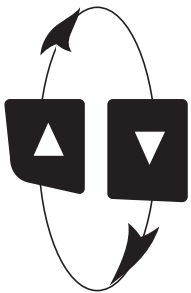

ProcessPro Editing Procedure:

Step 1. Press and hold ENTER key:

- 2 seconds to select the CALIBRATE menu.
- 5 seconds to select the OPTIONS menu.

Step 2. The Key Code is UP-UP-UP-DOWN keys in sequence.

- After entering the Key Code, the display will show the first item in the selected menu.

Step 3. Scroll menu with UP or DOWN arrow keys.

Step 4. Press RIGHT ARROW key to select menu item to be edited.

- The first display element will begin flashing.

Step 5. Press UP or DOWN keys to edit the flashing element.

- RIGHT ARROW key advances the flashing element.

Step 6. Press ENTER key to save the new setting and return to Step 3.

Notes on Step 1:

- The View Menu is normally displayed.
- The CALIBRATE and OPTIONS menus require a KEY CODE.

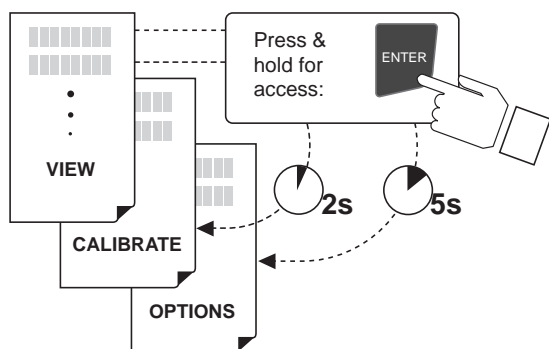

Notes on Step 2:

If no key is pressed for 5 minutes while display is showing "Enter Key Code", the display will return to the VIEW menu.

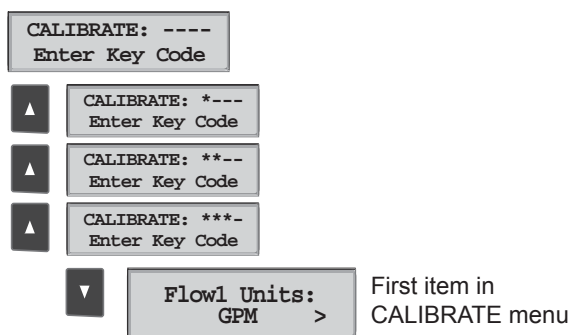

Notes on Steps 3 and 4:

- Refer to pages 6 and 7 for complete listing of menu items and their use.
- From the Step 3 display, pressing the UP and DOWN keys simultaneously will return the display to the VIEW menu.
- If no key is pressed for 10 minutes, display will also return to the VIEW menu.

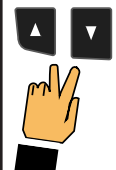

Step 3: Finished Editing?
Press the UP and DOWN keys simultaneously after saving the last setting to return to normal operation.

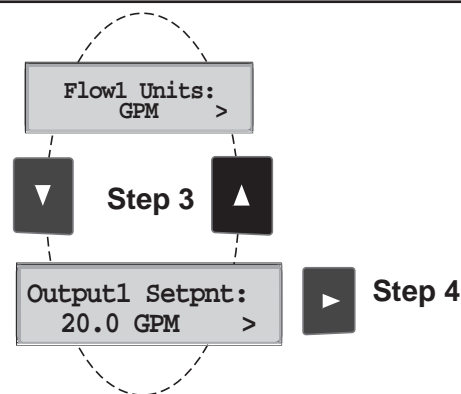

Notes on Steps 5 and 6:

- All output functions remain active during editing.
- Only the flashing element can be edited.
- RIGHT ARROW key advances the flashing element in a continuous loop.
- Edited value is effective immediately after pressing ENTER key.
- If no key is pressed for 10 minutes unit will restore the last saved value and return to step 3.
- Step 6 (pressing ENTER key) always returns you to Step 3.
- Repeat steps 3-6 until all editing is completed.

Step 5: Made an Error?

Press the UP and DOWN keys simultaneously while any element is flashing. This will recall the last saved value of the item being edited and return you to Step 3.



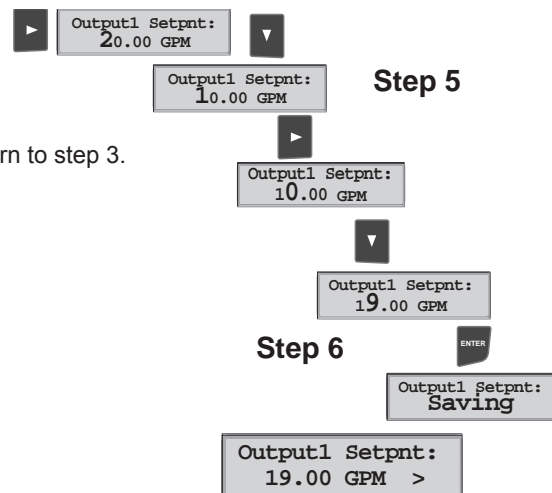

Calibrate Menu

Display (Factory settings shown)	Description
Flow1 Units: GPM >	The first three characters set the Flow Rate units of measure and have no effect on calculations. They may be any character, upper or lower case. The last character sets the Flow rate Timebase. Select S (seconds), M (minutes), H (hours) or D (days)
Flow1 K-Factor: 60.000	This setting converts the input frequency from the flow sensor into a flow rate. The K-Factor is unique to the sensor model and to the pipe size and schedule. Refer to data in the sensor manual for the correct value. Limits: 0.0001 to 99999. (The K-factor cannot be set to 0.)
Totall Units: Gallons	This setting identifies the Totalizer units. It has no effect on any calculation. It serves as a label only. Each character can be any alpha or numeric selection, upper or lower case.
Totall K-Factor 60.000 >	This setting converts the input frequency from the flow sensor into a volumetric total. It also is used as the basis for the Open Collector pulse mode. The setting is usually the same as the Flow K-Factor, or different by x10 or x100. Limits: 0.0001 to 99999. (Cannot be set to 0.)
Loop1 Source: Flow1 >	Select the input source to be associated with Loop output #1: Flow sensor #1, Flow sensor #2, or Delta Flow.
Loop1 Range: GPM 000.00 → 100.00 >	Select the minimum and maximum values for the Current loop output #1. The 8550 will allow any values from 0.0000 to 99999
Output1 Source: Flow1 >	Select the desired mode of operation for the Open Collector output. Options available are Flow sensor #1, Flow sensor #2, or Delta Flow.
Output1 Mode: Low >	Select the desired mode of operation for the Open Collector output #1. Options available are High, Low, volumetric Pulse, or Frequency. The signal may be disabled (Off) if not used.
Output1 Setpnt: 10.0 GPM >	In Low or High Mode, the Open Collector output #1 will be activated when the Flow rate reaches this value. Be sure to modify this setting if you change the Flow Units.
Output1 Hys: 5.0 GPM >	The Open Collector output will be deactivated at Setpoint ± Hysteresis, depending on High or Low Setpoint selection. (See details on page 4.)
Output1 Volume: 100.00 Gallons >	In Pulse mode, the Open collector output #1 will generate one pulse when this volume of flow passes the sensor. The measurement is based on the Total K-Factor. The 8550 will allow any value from 0.0001 to 99999.
Output PlsWdth: 0.1 Seconds >	In Pulse mode, this setting defines the duration of the Open Collector output pulse. The 8550 allows any value from 0.1 seconds to 999.9 seconds.
Output1 Freq.: Divide by 1 >	In Frequency mode, the Open Collector output will simulate the sensor frequency, divided by this setting. Set for 1 (input frequency = output frequency). Set for even numbers (2, 4, 6, 8 . . . 254 max) to scale output frequency.
Last CAL: 2-10-09	Use this "note pad" to record important dates, such as annual recertification or scheduled maintenance.

All functions labeled "1" will repeat for channel 2.

Options Menu

Display (Factory settings shown)	Description
Contrast: 3 >	Adjust the LCD contrast for best viewing. A setting of 1 is lowest contrast, 5 is highest. Select lower contrast if the display is in warmer ambient surroundings.
Flow1 Decimal *****. >	Set the decimal to the best resolution for your application. The display will automatically scale up to this resolution. Select *****, *****, ***, **, * or .****
Total1 Decimal *****. ** >	Set the totalizer decimal to the best resolution for your application. Select *****, *****, or *****
Averaging 1: Off >	OFF provides the quickest output response to changes in flow. Longer averaging period produces more stable display and output response. Select OFF, 8 s, 20 s, 50 s or 120 s.
Sensitivity 1: 0 >	Sensitivity works in conjunction with Averaging to balance response time with signal stability. Selections are 0 to 9. Select 0 (zero) for the minimum sensitivity, or 9 for the maximum sensitivity. The function is described below.
Total Reset Lock Off >	Lock Off : No key code required to reset the resettable totalizer. Lock On : The Key Code must be entered to reset the resettable totalizer.
Loop1 Adjust 4.00 mA >	Adjust the minimum and maximum current output. Use this setting to match the system output to any external device. The display value represents the precise current output. Adjustment limits: • 3.80 mA < 4.00 mA > 5.00 mA • 19.00 mA < 20.00 mA > 21.00 mA
Loop1 Adjust 20.00 mA >	
Output1 Active Low >	Active HIGH: This setting is used to turn a device (pump, valve) ON at the setpoint. Active LOW: This setting is used to turn a device OFF at the setpoint.
Test Loop1: >	Press UP or DOWN keys to manually order any output current value from 3.6 mA to 21.00 mA to test current loop output.
Test Output 1: >	Press UP or DOWN keys to manually toggle the state of open collector output.

All functions labeled "1" will repeat for channel 2.

----- No AVERAGING, no SENSITIVITY

With AVERAGING set to 0 (zero) and with SENSITIVITY set to zero, the 8550 responds to every unstable shift in the flow. The dashed red line represents the actual output of the flow sensor in unstable flow conditions .

----- AVERAGING only

With AVERAGING set to 50 seconds and SENSITIVITY still set to zero the flow rate is stabilized, but a sharp change in flow rate is not represented for 50 seconds or longer. (dotted green line).

----- AVERAGING and SENSITIVITY

With AVERAGING at 50 seconds and SENSITIVITY set to 4 OR 5, the flow rate is stabilized, while the sudden shift in flow is reflected very quickly. (Solid blue line)

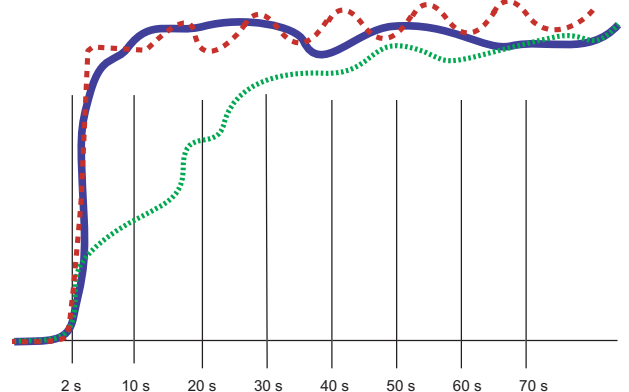

NOTE: The SENSITIVITY function is ineffective if the AVERAGING function is set to zero (seconds).

Troubleshooting

Display Condition	Possible Causes	Suggested Solutions
- - - - -	Flow rate exceeds display capability	<ul style="list-style-type: none"> • Increase Flow units time base • Move flow decimal one place to the right
Pulse Overrun	<ul style="list-style-type: none"> • Open Collector pulse rate exceeds maximum of 300 pulses per minute. • Pulse width set too wide. 	<ul style="list-style-type: none"> • Increase Pulse volume setting • Decrease pulse width setting. • Reduce system flow rate
Value must be more than 0	K-Factors cannot be set to 0.	Enter K-Factor from 0.0001 to 99999
Open Collector is always activated	<ul style="list-style-type: none"> • Hysteresis value too large • Defective transmitter 	<ul style="list-style-type: none"> • Change the hysteresis value • Replace transmitter

Ordering Information

Mfr. Part No.	Code	Description
3-8550-1	159 000 047	Flow transmitter, Field mount
3-8550-1P	159 000 048	Flow transmitter, Panel mount
3-8550-2	159 000 049	Flow transmitter, Field mount with relays
3-8550-2P	159 000 050	Flow transmitter, Panel mount with relays
3-8550-3	159 000 051	Flow transmitter, Field mount with dual input/output
3-8550-3P	159 000 052	Flow transmitter, Panel mount with dual input/output

Accessories

Mfr. Part No.	Code	Description
3-8050	159 000 184	Universal mounting kit
3-8051	159 000 187	Flow Integral Mnt NPT
3-8050.395	159 000 186	Splashproof rear cover
3-8050.396	159 000 617	RC Filter kit (for relay use)
3-0000.596	159 000 641	Heavy duty wall mount bracket
3-5000.598	198 840 225	Surface Mount Bracket
3-5000.399	198 840 224	5 x 5 inch adapter plate for Signet retrofit
3-9000.392	159 000 368	Liquid tight connector kit for rear cover (includes 3 connectors)
3-9000.392-1	159 000 839	Liquid tight connector kit, NPT (1 piece)
3-9000.392-2	159 000 841	Liquid tight connector kit, PG13.5 (1 piece)
7300-7524	159 000 687	24 VDC Power Supply 7.5 W, 300mA
7300-1524	159 000 688	24 VDC Power Supply 15 W, 600mA
7300-3024	159 000 689	24 VDC Power Supply 30 W, 1.3 A
7300-5024	159 000 690	24 VDC Power Supply 50 W, 2.1 A
7300-1024	159 000 691	24 VDC Power Supply 100 W, 4.2 A



Georg Fischer Signet LLC, 3401 Aerojet Avenue, El Monte, CA 91731-2882 U.S.A. • Tel. (626) 571-2770 • Fax (626) 573-2057
 For Worldwide Sales and Service, visit our website: www.gfsignet.com • Or call (in the U.S.): (800) 854-4090
 For the most up-to-date information, please refer to our website at www.gfsignet.com