

Product Range

Variable Area
Flow Meters
Type 335, Type 350
Short Version
Special Version



+GF+

GEORG FISCHER
PIPING SYSTEMS

Key

PVC-U	Polyvinyl chloride, unplasticized
PVDF	Polyvinylidene fluoride
PSU	Polysulphone
PA	Polyamide
EPDM	Ethylene Propylene Rubber
FPM	Fluororubber, e.g. Viton®
PTFE	Polytetrafluoroethylene, e.g. Teflon®
d	Pipe outer diameter
DN	Nominal diameter
PN	Nominal pressure at 20° C, water
kg	Weight in kilograms
®	Registered trademark
HP	High Purity
IR	Infrared fusion
WNF/BCF	Wulst- und Nutfrei/Bead & Crevice-Free
GK	Grenzwertkontakt/Limit switch
VAFM	Variable area flow meter

Dimensions

All dimensions are given in mm.

Table of Contents

Variable Area Flow Meter Type 335, Type 350, Short Version, Special Version

Introduction to Variable Area Flow Meters	7
Variable Area Flow Meter Type 335	
- without magnet in the materials PVC-U, PA and PSU	10
- with magnet in the materials PVC-U, PA and PSU	11
Variable Area Flow Meter Type 350	
- without magnet in the materials PVC-U, PA and PSU	12
- with magnet in the materials PVC-U, PA and PSU	13
Variable Area Flow Meter Short Version	
- without magnet in the materials PVC-U, PA and PSU	14
- with magnet in the materials PVC-U, PA and PSU	14
Variable Area Flow Meter Special Version	
- PVDF HP	15
- PVDF	15
Accessories	
- Limit contacts	16
- Special scales	18
Spare Parts	
- Type 335	23
- Type 350	26
- Short version	30
Adjustment Factors	32

➤ Reliably handles large flow volumes



Easy, accurate and reliable



The Georg Fischer name stands for reliability and durability. Our products guarantee quality, innovation and functionality. The new variable area flow meter continues in this tradition. With the flow meters type 335 and 350, as well as the type series SK- short version and the special versions in PVDF, GF Piping Systems offers radially dismountable measurement devices for flow measurement in industrial piping systems. These instruments supply accurate measurement values without an energy source.

A variety of installation lengths

The variable area flow meters are now available in the installation length 335 mm, 350 mm, 200 mm, 185 mm and 165 mm. The taper tubes are available in polyamide,

polysulphone and transparent PVC-U. The standard floats are in PVDF with or without magnet. The end stops are in PVDF. The threaded joint including insert is available in PVC-U, as well as in PP or ABS on request. The O-rings are made of EPDM or FPM. The nominal pressure is 10 bar at 20°C.

Broad fields of applications

All the flow meters are equipped with a double scale: a percentage scale as well as a scale for the flow volume. The standard scale is printed in l/h. Special scales are on offer for m³/h, GPM, in addition to special graduations for HCl, NaOH and air and can be affixed on taper tubes without scales subsequently. Measuring accuracy falls in the accuracy class 4 according to VDE/VDI 3513 Sheet 2.

The variable area flow meters from GF Piping Systems appear with a new design. With the type 350 the range of products has been enlarged by a new installation length. The different installation lengths in a variety of materials and special designs offer optimal solutions for use in diverse media.

➤ Know your flow

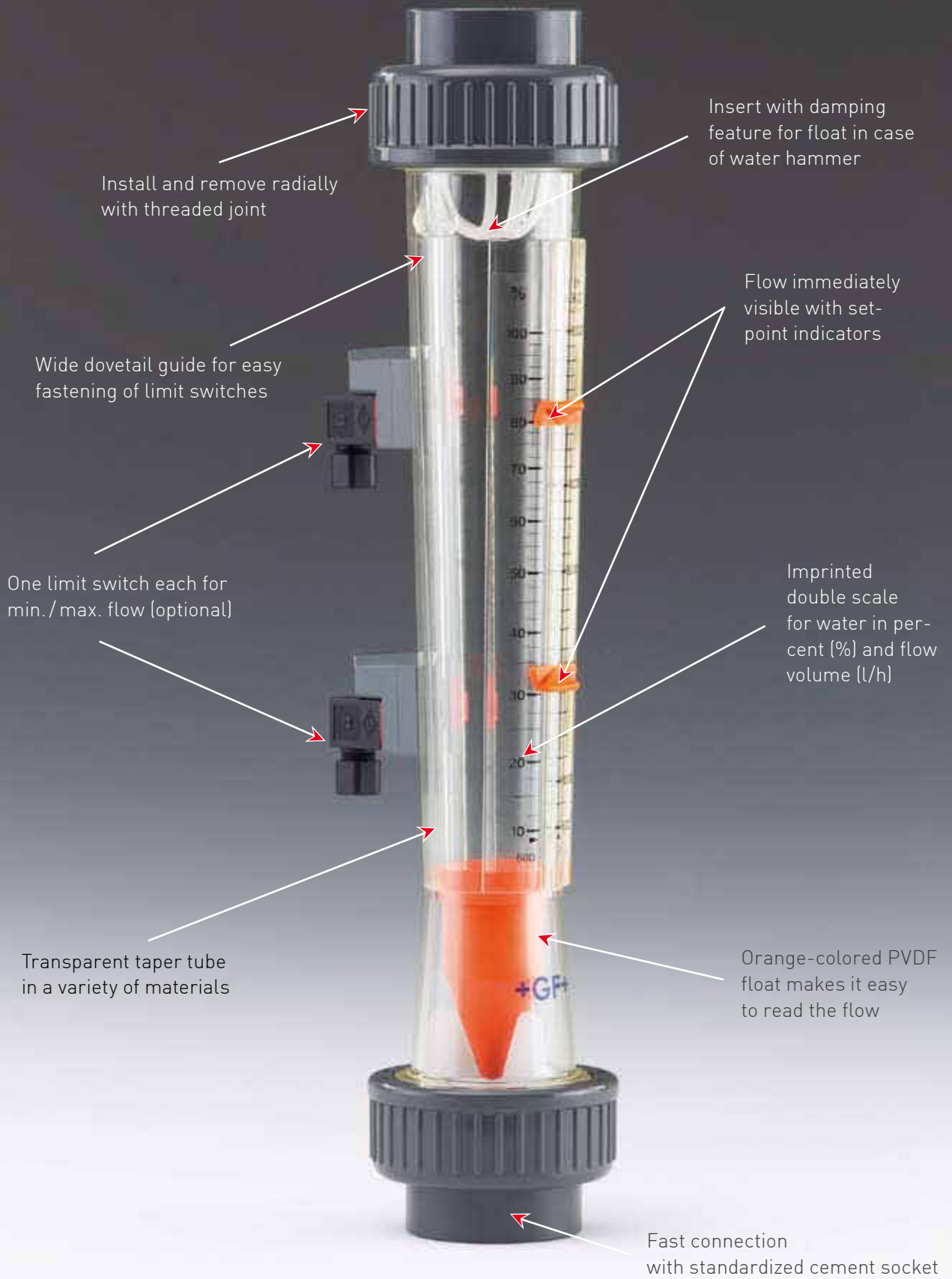

Install and remove radially with threaded joint

Insert with damping feature for float in case of water hammer

Wide dovetail guide for easy fastening of limit switches

Flow immediately visible with set-point indicators

One limit switch each for min. / max. flow (optional)

Imprinted double scale for water in percent (%) and flow volume (l/h)

Transparent taper tube in a variety of materials

Orange-colored PVDF float makes it easy to read the flow

Fast connection with standardized cement socket

Introduction to Variable Area Flow Meters

The plastic variable area flow meters type 335/ 350 from GF piping systems are radially installed dismountable meters for flow rate measuring in industrial piping applications. The measurement ranges, which are attuned to our customers' needs, and the range of materials available for the tubes and screwed fittings, mean that the flow meters can be used for a wide range of applications and a great variety of media.

Mode of operation

If a medium flows upwards at a sufficient rate of flow through the vertically mounted taper tube, the float is raised to the point at which a state of equilibrium sets in between the lifting force of the medium and the weight of the float. Since the mean rate of flow is proportional to the quantity flowing through per unit of time, this state of equilibrium corresponds to the measurement of the instantaneous flow rate.

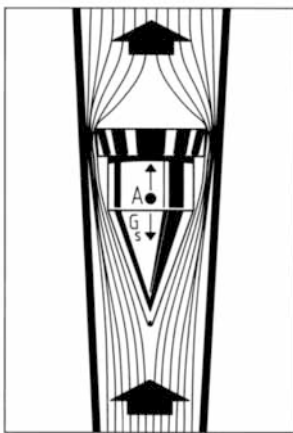

Installation in the piping system

Before installing

1. The net in which the float is wrapped must be removed. To do this, the upper union nut is unscrewed and the upper insert including seals is removed.
2. Then the VAFM must be reassembled.
3. The pipe system into which the VAFM is built must be in a vertical position to ensure its functionality.
4. An inlet and outlet section must be provided for. (inlet ca. 10 x DN, outlet ca. 5 x DN)

While installing

- The VAFM must be installed tension-free.
- It should be ascertained that taper tube does not come into contact with solvents so that the indicator scale is not damaged.
- Prior to initial operation, check that all parts are properly connected.

After installing

The top edge of the float indicates the flow volume.

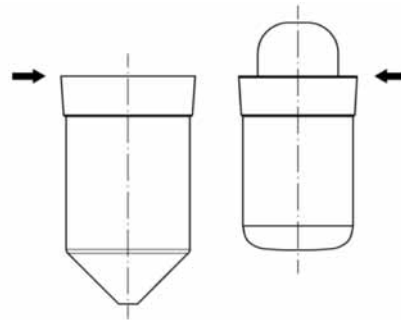

If special scales are applied subsequently, it must be ascertained that the scale marking >is affixed congruently with the one on the taper tube.

Pressure range

Nominal pressure 10 bar at 20 °C

Materials

Tube:	Polyamid , Polysulphone, PVDF and PVC-U transparent
Float:	PVDF, PTFE
End stops:	PVDF
Screw connection:	PVC-U (PP, PVDF, ABS)
O-ring:	EPDM (FPM)
Guiding rod:	Peek

Calibrated scales

The standard version comes with a printed on double scale: a percentage scale and a scale giving flow rate (H₂O l/h).

The special scales come as a sticker and need to be fitted to a blank taper tube. The scales are adhesive bonded to the tube and are printed with a special hard wearing paint.

Standard scale: l/h

Special scales: m³/h, GPM

Scales for other liquids: HCl 30-33%, NaOH 30%, NaOH 50% and air

Accuracy of measurement

In accordance with VDE/VDI 3513 sheet 2, accuracy class 4

1. Part failure $\pm 3\%$ related to the measured value
2. Part failure $\pm 1\%$ related to the full scale

Flow rate %	1. part failure		2. part failure		Total measurement error	
	% of measured value	% of full scale value	% of measured value	% of full scale value	% of measured value	% of full scale value
100	3.0	3.0	1.000	1.000	4.000	4.000
90	3.0	2.7	1.111	1.000	4.111	3.700
80	3.0	2.4	1.250	1.000	4.250	3.400
70	3.0	2.1	1.429	1.000	4.429	3.100
60	3.0	1.8	1.667	1.000	4.667	2.800
50	3.0	1.5	2.000	1.000	5.000	2.500
40	3.0	1.2	2.500	1.000	5.500	2.200
30	3.0	0.9	3.333	1.000	6.333	1.900
20	3.0	0.6	5.000	1.000	8.000	1.600
10	3.0	0.3	10.000	1.000	13.000	1.300

Temperature range

To determine the maximum internal pressure, we refer you to our material-related pressure/temperature charts.

max. temperature range at 2 bar (taper tube with union):

PVC-U transparent with PVC-U fitting	0 to +60 °C
Polyamid and Polysulphone with PVC-U fitting	0 to +60 °C
Polysulphone with PP-PVDF union nut	0 to +90 °C
PVDF with PVDF union nut	0 to +100 °C

Pressure loss for type 335/ 350

DN	Loss (mmWP)	Loss (mbar)
25	256.4	25.46
32	256.4	25.46
40	300.2	30.02
50	300.2	30.02
65	459.5	56.59
65*	481.3	48.13

* measuring range 8'000-60'000 l/h

Chemical resistance list

Chemical				PVC-U	Trogamid	PSU	PVDF	Peek
Acid	phosphoric acid	H ₃ PO ₄	75%	X	O	X	X	X
	sulfuric acid	H ₂ SO ₄	<90%	X	-	-	X	-
	nitric acid	HNO ₃	<55%	X	-	-	X	-
	nitric acid	HNO ₃	67%	-	-	-	X	-
	hydrofluoric acid	HF	<70%	X	-	-	X	-
	hydrochloric acid	HCl	36%	X	O	X	X	O
Base	ammonia	NH ₄ OH	25%	X	X	X	-	X
	caustic potash	KOH	>50%	X	O	X	-	X
	caustic soda	NaOH	<50%	X	O	X	-	X
Anorganica	ferric chloride	FeCl ₃		X	X	X	X	X
	sodium hydrochloride	NaOCl	15%	X	X	X	-	X
	sodium bisulfite	NaHSO ₃	<40%	X	X	X	X	X
	hydrogen peroxide	H ₂ O ₂	35%	X	-	X	O	X
	aqueous inorganic saline solutions (not oxidizing)	til saturation		X	X	X	X	X
Organica	formic acid	HCOOH	85%	O	-	O	O	O
	acetic acid	CH ₃ COOH	85%	O	-	O	O	O
	formaldehyde	H ₂ CO	<40%	X	-	X	O	X
	glycol		<50%	O	-	X	X	X
	acetone	undiluted		-	O	-	O	X
	ethanol, methanol	undiluted		O	-	X	X	X
	aliphatic hydrocarbons	undiluted		O	X	X	X	X

Valid for 40°C and 2bar

X: recommended

O: with limitations

-: not recommended

For higher or lower concentrations than mentioned in the list or entry "O", please contact gss@georgfischer.com



Variable area flow meter type 335
Float in PVDF without magnet
With solvent cement sockets PVC-U
metric



Scale range [l/h]	d [mm]	DN [mm]	Taper tube in PVC-U transp. O-rings in EPDM Code	Taper tube in Polyamid O-rings in EPDM Code	Taper tube in Polysulfone O-rings in EPDM Code
50 - 500	32	25	198 335 000	198 335 020	198 335 040
100 - 1000	32	25	198 335 001	198 335 021	198 335 041
150 - 1500	40	32	198 335 002	198 335 022	198 335 042
250 - 2500	40	32	198 335 003	198 335 023	198 335 043
200 - 2000	50	40	198 335 004	198 335 024	198 335 044
300 - 3000	50	40	198 335 005	198 335 025	198 335 045
600 - 6000	50	40	198 335 006	198 335 026	198 335 046
600 - 6000	63	50	198 335 007	198 335 027	198 335 047
1000 - 10000	63	50	198 335 008	198 335 028	198 335 048
1500 - 15000	63	50	198 335 009	198 335 029	198 335 049
2000 - 20000	75	65	198 335 010	198 335 030	198 335 050
3000 - 30000	75	65	198 335 011	198 335 031	198 335 051
8000 - 60000	75	65	198 335 012	198 335 032	198 335 052

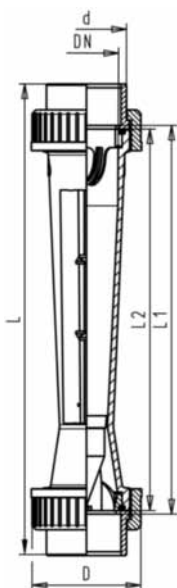

Scale range [l/h]	D [mm]	L [mm]	L1 [mm]	L2 [mm]	G [inch]
50 - 500	58	385	341	335	1 ½
100 - 1000	58	385	341	335	1 ½
150 - 1500	72	393	341	335	2
250 - 2500	72	393	341	335	2
200 - 2000	83	403	341	335	2 ¼
300 - 3000	83	403	341	335	2 ¼
600 - 6000	83	403	341	335	2 ¼
600 - 6000	101	417	341	335	2 ¾
1000 - 10000	101	417	341	335	2 ¾
1500 - 15000	101	417	341	335	2 ¾
2000 - 20000	135	429	341	335	3 ½
3000 - 30000	135	429	341	335	3 ½
8000 - 60000	135	429	341	335	3 ½

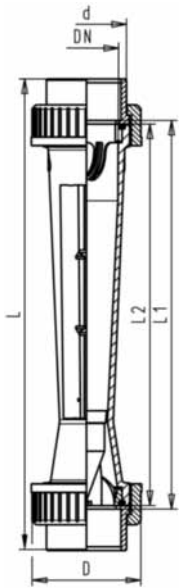

Variable area flow meter type 335 Float in PVDF with magnet With solvent cement sockets PVC-U metric



Model:

- Suitable limit switches see accessories for variable area flow meters

Scale range [l/h]	d [mm]	DN [mm]	Taper tube in PVC-U transp. O-Rings in EPDM Code	Taper tube in Polyamid O- rings in EPDM Code	Taper tube in Polysulfone O- rings in EPDM Code	
50 - 500	32	25	198 335 100	198 335 120	198 335 140	
100 - 1000	32	25	198 335 101	198 335 121	198 335 141	
150 - 1500	40	32	198 335 102	198 335 122	198 335 142	
250 - 2500	40	32	198 335 103	198 335 123	198 335 143	
200 - 2000	50	40	198 335 104	198 335 124	198 335 144	
300 - 3000	50	40	198 335 105	198 335 125	198 335 145	
600 - 6000	50	40	198 335 106	198 335 126	198 335 146	
600 - 6000	63	50	198 335 107	198 335 127	198 335 147	
1000 - 10000	63	50	198 335 108	198 335 128	198 335 148	
1500 - 15000	63	50	198 335 109	198 335 129	198 335 149	
2000 - 20000	75	65	198 335 110	198 335 130	198 335 150	
3000 - 30000	75	65	198 335 111	198 335 131	198 335 151	
8000 - 60000	75	65	198 335 112	198 335 132	198 335 152	

Scale range [l/h]	D [mm]	L [mm]	L1 [mm]	L2 [mm]	G [inch]	
50 - 500	58	385	341	335	1 ½	
100 - 1000	58	385	341	335	1 ½	
150 - 1500	72	393	341	335	2	
250 - 2500	72	393	341	335	2	
200 - 2000	83	403	341	335	2 ¼	
300 - 3000	83	403	341	335	2 ¼	
600 - 6000	83	403	341	335	2 ¼	
600 - 6000	101	417	341	335	2 ¾	
1000 - 10000	101	417	341	335	2 ¾	
1500 - 15000	101	417	341	335	2 ¾	
2000 - 20000	135	429	341	335	3 ½	
3000 - 30000	135	429	341	335	3 ½	
8000 - 60000	135	429	341	335	3 ½	



Variable area flow meter type 350
Float in PVDF without magnet
With solvent cement sockets PVC-U
metric



Scale range [l/h]	d [mm]	DN [mm]	Taper tube in PVC-U transp. O-rings in EPDM Code	Taper tube in Polyamid O- rings in EPDM Code	Taper tube in Polysulfone O- rings in EPDM Code
50 - 500	32	25	198 350 000	198 350 020	198 350 040
100 - 1000	32	25	198 350 001	198 350 021	198 350 041
150 - 1500	40	32	198 350 002	198 350 022	198 350 042
250 - 2500	40	32	198 350 003	198 350 023	198 350 043
200 - 2000	50	40	198 350 004	198 350 024	198 350 044
300 - 3000	50	40	198 350 005	198 350 025	198 350 045
600 - 6000	50	40	198 350 006	198 350 026	198 350 046
600 - 6000	63	50	198 350 007	198 350 027	198 350 047
1000 - 10000	63	50	198 350 008	198 350 028	198 350 048
1500 - 15000	63	50	198 350 009	198 350 029	198 350 049
2000 - 20000	75	65	198 350 010	198 350 030	198 350 050
3000 - 30000	75	65	198 350 011	198 350 031	198 350 051
8000 - 60000	75	65	198 350 012	198 350 032	198 350 052

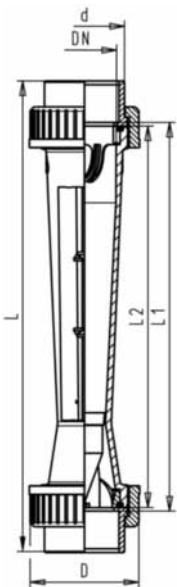

Scale range [l/h]	D [mm]	L [mm]	L1 [mm]	L2 [mm]	G [inch]
50 - 500	58	400	356	350	1 ½
100 - 1000	58	400	356	350	1 ½
150 - 1500	72	408	356	350	2
250 - 2500	72	408	356	350	2
200 - 2000	83	418	356	350	2 ¼
300 - 3000	83	418	356	350	2 ¼
600 - 6000	83	418	356	350	2 ¼
600 - 6000	101	432	356	350	2 ¾
1000 - 10000	101	432	356	350	2 ¾
1500 - 15000	101	432	356	350	2 ¾
2000 - 20000	135	444	356	350	3 ½
3000 - 30000	135	444	356	350	3 ½
8000 - 60000	135	444	356	350	3 ½

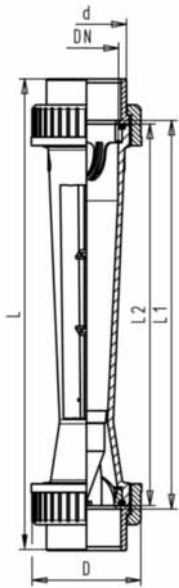

Variable area flow meter type 350 Float in PVDF with magnet With solvent cement sockets PVC-U metric



Model:

- Suitable limit switches see accessories for variable area flow meters

Scale range [l/h]	d [mm]	DN [mm]	Taper tube in PVC-U transp. O-Rings in EPDM Code	Taper tube in Polyamid O- rings in EPDM Code	Taper tube in Polysulfone O- rings in EPDM Code	
50 - 500	32	25	198 350 100	198 350 120	198 350 140	
100 - 1000	32	25	198 350 101	198 350 121	198 350 141	
150 - 1500	40	32	198 350 102	198 350 122	198 350 142	
250 - 2500	40	32	198 350 103	198 350 123	198 350 143	
200 - 2000	50	40	198 350 104	198 350 124	198 350 144	
300 - 3000	50	40	198 350 105	198 350 125	198 350 145	
600 - 6000	50	40	198 350 106	198 350 126	198 350 146	
600 - 6000	63	50	198 350 107	198 350 127	198 350 147	
1000 - 10000	63	50	198 350 108	198 350 128	198 350 148	
1500 - 15000	63	50	198 350 109	198 350 129	198 350 149	
2000 - 20000	75	65	198 350 110	198 350 130	198 350 150	
3000 - 30000	75	65	198 350 111	198 350 131	198 350 151	
8000 - 60000	75	65	198 350 112	198 350 132	198 350 152	

Scale range [l/h]	D [mm]	L [mm]	L1 [mm]	L2 [mm]	G [inch]	
50 - 500	58	400	356	350	1 ½	
100 - 1000	58	400	356	350	1 ½	
150 - 1500	72	408	356	350	2	
250 - 2500	72	408	356	350	2	
200 - 2000	83	418	356	350	2 ¼	
300 - 3000	83	418	356	350	2 ¼	
600 - 6000	83	418	356	350	2 ¼	
600 - 6000	101	432	356	350	2 ¾	
1000 - 10000	101	432	356	350	2 ¾	
1500 - 15000	101	432	356	350	2 ¾	
2000 - 20000	135	444	356	350	3 ½	
3000 - 30000	135	444	356	350	3 ½	
8000 - 60000	135	444	356	350	3 ½	

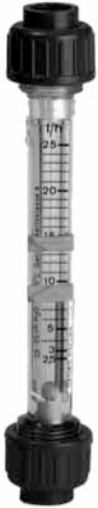

Short version Float in PVDF without magnet With solvent cement sockets PVC-U metric

Model:

- Union nuts and valve ends in other materials on request

Type	d [mm]	DN [mm]	Scale range [l/h]	Taper tube in Polysulfone O-rings in EPDM Code	Taper tube in PVC-U transp. O-rings in EPDM Code
SK 50	16	10	2.5 - 25	198 801 880	198 803 310
SK 51	16	10	5 - 50	198 801 881	198 803 311
SK 52	16	10	10 - 100	198 801 882	198 803 312
SK 60	20	15	8 - 80	198 801 883	198 803 313
SK 61	20	15	15 - 150	198 801 884	198 803 314
SK 62	20	15	20 - 200	198 801 885	198 803 315
SK 70	32	25	15 - 150	198 801 886	198 803 316
SK 71	32	25	30 - 300	198 801 887	198 803 317
SK 72	32	25	50 - 500	198 801 888	198 803 318
SK 73	32	25	100 - 1000	198 801 889	198 803 319

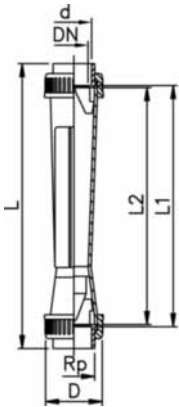

Type	D [mm]	L [mm]	L1 [mm]	L2 [mm]	Rp [inch]
SK 50	35	199	171	165	3/8
SK 51	35	199	171	165	3/8
SK 52	35	199	171	165	3/8
SK 60	43	223	191	185	1/2
SK 61	43	223	191	185	1/2
SK 62	43	223	191	185	1/2
SK 70	60	250	206	200	1
SK 71	60	250	206	200	1
SK 72	60	250	206	200	1
SK 73	60	250	206	200	1

Short version Float in PVDF with magnet With solvent cement sockets PVC-U metric

Model:

- Union nuts and valve ends in other materials on request
- Suitable limit switches see accessories for variable area flow meters

Type	d [mm]	DN [mm]	Scale range [l/h]	Taper tube in Polysulfone O-rings in EPDM Code	Taper tube in PVC-U transp. O-rings in EPDM Code
SK 500	16	10	2.5 - 25	198 801 890	198 803 320
SK 510	16	10	5 - 50	198 801 891	198 803 321
SK 520	16	10	10 - 100	198 801 892	198 803 322
SK 600	20	15	8 - 80	198 801 893	198 803 323
SK 610	20	15	15 - 150	198 801 894	198 803 324
SK 620	20	15	20 - 200	198 801 895	198 803 325
SK 700	32	25	15 - 150	198 801 896	198 803 326
SK 710	32	25	30 - 300	198 801 897	198 803 327
SK 720	32	25	50 - 500	198 801 898	198 803 328
SK 730	32	25	100 - 1000	198 801 899	198 803 329

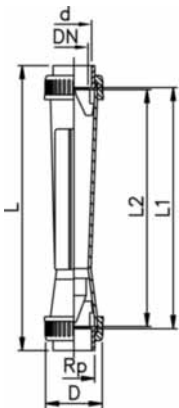

Type	D [mm]	L [mm]	L1 [mm]	L2 [mm]	Rp [inch]
SK 500	35	199	171	165	3/8
SK 510	35	199	171	165	3/8
SK 520	35	199	171	165	3/8
SK 600	43	223	191	185	1/2
SK 610	43	223	191	185	1/2
SK 620	43	223	191	185	1/2
SK 700	60	250	206	200	1
SK 710	60	250	206	200	1
SK 720	60	250	206	200	1
SK 730	60	250	206	200	1



Special version PVDF-HP Float in PTFE without magnet With fusion spigots BCF/IR

Type	d [mm]	DN [mm]	Scale range [l/h]	Scale range [gal/min]	Taper tube in Polysulfone O-rings in FPM Code
SK 70	32	25	68 - 204	0.3-0.9	198 807 209
SK 71	32	25	90 - 295	0.4-1.3	198 807 210
SK 73	32	25	136 - 795	0.6-3.5	198 807 202
SK 20	50	40	568 - 2273	2.5-10.0	198 807 203
SK 21	50	40	909 - 4091	4.0-18.0	198 807 204
SK 30	63	50	1000 - 8142	4.4-36.0	198 807 205
SK 31	63	50	1000 - 9091	4.4-40.0	198 807 206
SK 40	75	65	1848 - 11364	8.0-50.0	198 807 207
SK 41	75	65	2273 - 16364	10.0-72.0	198 807 208

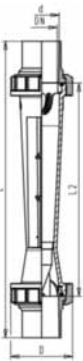

Type	D [mm]	L [mm]	L1 [mm]	L2 [mm]	Rp [inch]
SK 70	60	318		200	1
SK 71	60	318		200	1
SK 73	60	318		200	1
SK 20	83	466		335	1 ½
SK 21	83	466		335	1 ½
SK 30	103	472		335	2
SK 31	103	472		335	2
SK 40	122	495		335	2 ½
SK 41	122	495		335	2 ½

Special version PVDF Float in PVDF (red) without magnet

Dimension L and L1 only valid for socket connection
Dimension L2 describes taper tube length



Type	d [mm]	DN [mm]	Scale range [l/h]	Taper tube in PVDF O-rings in FPM fusion socket Code	Taper tube in PVDF O-rings in FPM IR fusion spigot Code
SK 10	32	25	50 - 500	198 806 466	198 803 905
SK 11	32	25	100 - 1000	198 806 467	198 803 906
SK 20	50	40	200 - 2000	198 806 468	198 803 907
SK 21	50	40	300 - 3000	198 806 469	198 803 908
SK 30	63	50	600 - 6000	198 806 470	198 803 909
SK 31	63	50	1200 - 12000	198 806 471	198 803 910
SK 40	75	65	2000 - 20000	-	198 803 911
SK 41	75	65	3000 - 30000	-	198 803 912

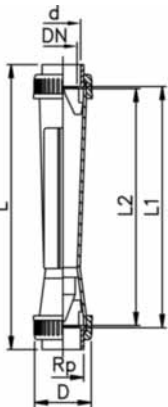

Type	D [mm]	L [mm]	L (IR-SS) [mm]	L1 [mm]	L2 [mm]	Rp [inch]
SK 10	60	385	443	341	335	1
SK 11	60	385	443	341	335	1
SK 20	83	403	459	341	335	1 ½
SK 21	83	403	459	341	335	1 ½
SK 30	103	417	461	339	335	2
SK 31	103	417	461	339	335	2
SK 40	122	429	453	341	335	2 ½
SK 41	122	429	453	341	335	2 ½

Accessories

Limit contacts

Variable area flow meters from George Fischer are equipped with two dovetail shafts. For external electrical monitoring, these can be used for fitting magnetically actuated limit contacts.

Function of the limit contact (GK)



The limit contact serves to monitor externally the limited flow values and can be adjusted to any flow value on the corresponding scale. The magnet built into the float closes or opens a reed contact in the limit contact. This is a bistable switching function because the switching status remains when the float is taken from the contact.

Note: When subsequently mounting limit contacts, mind that you have to replace the standard float with a magnetic float.

The limit contacts GK10/ GK11 are only suitable for the VAFM type 335/ 350 as well as the short version of the existing range. The same contact type can not be used for monitoring both the min. and max. levels. (GK 10min / GK11 max)

Technical data to contacts

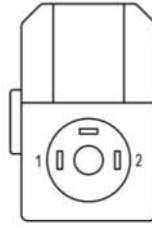

Connection: Standard plug DIN 40050
 Contact fitted: Reed contact
 Mode of protection: IP 65
 Max. voltage: 230 V
 Max. continuous current: 0.2 A
 Peak switch-on current: 0.5 A



For use with inductive loads, use a relay to protect the contacts

Assembly instructions

1. Replace the float with a magnetic float.
2. Position the limit contact on the dovetail shaft of the VAFM.
3. Tighten fastening screw.

Mode of operation of contacts

Position of float in relation to limit contacts:

	Top	Bottom
max. contact (GK11)	closed	open
min. contact (GK10)	open	closed

The contacts remain in these positions, even if the float leaves the contact concerned. When the float moves back to the desired position, the corresponding contact is deactivated.

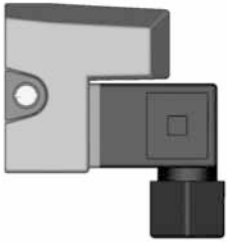

Limit contacts GK10/GK11 For type 335 and type 350

Model:

- For all dimensions type 335/350

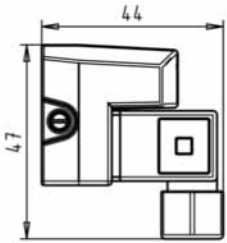

Type	Code	
GK10 (min.)	198 335 960	
GK11 (max.)	198 335 961	

Special scale for type 335/350 m³/h

d [mm]	DN [mm]	Scale range [m ³ /h]	Corresponds to water scale [l/h]	Code
32	25	0,05 - 0,5	50-500	198 335 655
32	25	0,1 - 1	100-1000	198 335 656
40	32	0,15 - 1,5	150-1500	198 335 657
40	32	0,25 - 2,5	250-2500	198 335 658
50	40	0,2 - 2,0	200-2000	198 335 659
50	40	0,3 - 3	300-3000	198 335 660
50	40	0,6 - 6	600-6000	198 335 661
63	50	0,6 - 6	600-6000	198 335 662
63	50	1 - 10	1000-10000	198 335 663
63	50	1,5 - 15	1500-15000	198 335 664
75	65	2 - 20	2000-20000	198 335 665
75	65	3 - 30	3000-30000	198 335 666
75	65	8 - 60	8000-60000	198 335 667

Special scale for type 335/350 Imp. GPM

d [mm]	DN [mm]	Scale range [gal/min]	Corresponds to water scale [l/h]	Code
32	25	0,183 - 1,83	50-500	198 335 670
32	25	0,366 - 3,66	100-1000	198 335 671
40	32	0,55 - 5,5	150-1500	198 335 672
40	32	0,916 - 9,16	250-2500	198 335 673
50	40	0,733 - 7,33	200-2000	198 335 674
50	40	1,09 - 10,9	300-3000	198 335 675
50	40	2,19 - 21,9	600-6000	198 335 676
63	50	2,2 - 22	600-6000	198 335 677
63	50	3,66 - 36,6	1000-10000	198 335 678
63	50	5,49 - 54,9	1500-15000	198 335 679
75	65	7,32 - 73,2	2000-20000	198 335 680
75	65	10,98 - 109,8	3000-30000	198 335 681
75	65	29,28 - 219,6	8000-60000	198 335 682

Special scale for type 335/350 US GPM

d [mm]	DN [mm]	Scale range [gal/min]	Corresponds to water scale [l/h]	Code
32	25	0,22 - 2,2	50-500	198 335 685
32	25	0,44 - 4,4	100-1000	198 335 686
40	32	0,66 - 6,6	150-1500	198 335 687
40	32	1,1 - 11	250-2500	198 335 688
50	40	0,66 - 6,6	200-2000	198 335 689
50	40	1,32 - 13,2	300-3000	198 335 690
50	40	2,64 - 26,4	600-6000	198 335 691
63	50	2,64 - 26,4	600-6000	198 335 692
63	50	4,40 - 44,02	1000-10000	198 335 693
63	50	6,60 - 66,04	1500-15000	198 335 694
75	65	8,80 - 88	2000-20000	198 335 695
75	65	13,20 - 132	3000-30000	198 335 696
75	65	35,2 - 264	8000-60000	198 335 697

Special scale for type 335/350 Air/0bar/Nm³/h

d [mm]	DN [mm]	Scale range [m ³ /h]	Corresponds to water scale [l/h]	Code
32	25	1,5 - 14	50-500	198 350 655
32	25	2,5 - 29	100-1000	198 350 656
40	32	4 - 45	150-1500	198 350 657
40	32	7 - 79	250-2500	198 350 658
50	40	6 - 58	200-2000	198 350 659
50	40	9 - 108	300-3000	198 350 660
50	40	17 - 174	600-6000	198 350 661
63	50	17 - 175	600-6000	198 350 662
63	50	29 - 301	1000-10000	198 350 663

table continued next page

d [mm]	DN [mm]	Scale range [m³/h]	Corresponds to water scale [l/h]	Code
63	50	53 - 405	1500-15000	198 350 664
75	65	55 - 545	2000-20000	198 350 665
75	65	80 - 758	3000-30000	198 350 666
75	65	-	8000-60000	198 350 667

Special scale for type 335/350 HCl 30-33% l/h

d [mm]	DN [mm]	Scale range [l/h]	Corresponds to water scale [l/h]	Code
32	25	20 - 405	50-500	198 350 670
32	25	55 - 866	100-1000	198 350 671
40	32	90 - 1340	150-1500	198 350 672
40	32	165 - 2310	250-2500	198 350 673
50	40	115 - 1660	200-2000	198 350 674
50	40	190 - 3050	300-3000	198 350 675
50	40	420 - 4900	600-6000	198 350 676
63	50	430 - 5090	600-6000	198 350 677
63	50	750 - 9460	1000-10000	198 350 678
63	50	1415 - 11570	1500-15000	198 350 679
75	65	1500 - 17300	2000-20000	198 350 680
75	65	2175 - 24120	3000-30000	198 350 681
75	65	-	8000-60000	198 350 682

Special scale for type 335/350 NaOH 30% l/h

d [mm]	DN [mm]	Scale range [l/h]	Corresponds to water scale [l/h]	Code
32	25	4 - 226	50-500	198 350 685
32	25	15 - 600	100-1000	198 350 686
40	32	30 - 970	150-1500	198 350 687
40	32	70 - 1800	250-2500	198 350 688
50	40	35 - 1240	200-2000	198 350 689
50	40	75 - 2370	300-3000	198 350 690
50	40	230 - 4000	600-6000	198 350 691
63	50	240 - 470	600-6000	198 350 692
63	50	475 - 7340	1000-10000	198 350 693
63	50	1030 - 10330	1500-15000	198 350 694
75	65	915 - 11720	2000-20000	198 350 695
75	65	1195 - 16040	3000-30000	198 350 696
75	65	-	8000-60000	198 350 697

Special scale for type 335/350 NaOH 50% l/h

d [mm]	DN [mm]	Scale range [l/h]	Corresponds to water scale [l/h]	Code
32	25	1 - 55	50-500	198 350 755
32	25	3 - 192	100-1000	198 350 756
40	32	6 - 365	150-1500	198 350 757
40	32	15 - 770	250-2500	198 350 758
50	40	8 - 520	200-2000	198 350 759
50	40	15 - 1170	300-3000	198 350 760
50	40	50 - 2270	600-6000	198 350 761
63	50	55 - 2300	600-6000	198 350 762
63	50	140 - 4340	1000-10000	198 350 763
63	50	420 - 5820	1500-15000	198 350 764
75	65	245 - 7590	2000-20000	198 350 765
75	65	400 - 11120	3000-30000	198 350 766
75	65	-	8000-60000	198 350 767

Special scale for short version Water l/h

Type	Scale range [l/h]	Code	
SK 50 / 500	2,5 - 25	198 801 386	
SK 51 / 510	5 - 50	198 801 387	
SK 52 / 520	10 - 100	198 801 388	
SK 60 / 600	8 - 80	198 801 389	
SK 61 / 610	15 - 150	198 801 390	
SK 62 / 620	20 - 200	198 801 391	
SK 70 / 700	15 - 150	198 801 392	
SK 71 / 710	30 - 300	198 801 393	
SK 72 / 720	50 - 500	198 801 394	
SK 73 / 730	100 - 1000	198 801 395	

Special scale for short version US GPM

Type	Scale range [gal/min]	Code	
SK 50 / 500	0,01 - 0,11	198 801 961	
SK 51 / 510	0,02 - 0,22	198 801 962	
SK 52 / 520	0,04 - 0,44	198 801 963	
SK 60 / 600	0,03 - 0,35	198 801 964	
SK 61 / 610	0,06 - 0,66	198 801 965	
SK 62 / 620	0,08 - 0,88	198 801 966	
SK 70 / 700	0,06 - 0,66	198 801 967	
SK 71 / 710	0,13 - 1,32	198 801 968	
SK 72 / 720	0,22 - 2,20	198 801 969	
SK 73 / 730	0,44 - 4,40	198 801 970	

Special scale for short version Air/0bar/Nm³/h

Type	Scale range [m ³ /h]	Code	
SK 50 / 500	0,5 - 0,95	198 801 308	
SK 51 / 510	0,5 - 1,9	198 801 309	
SK 52 / 520	0,8 - 3,0	198 801 310	
SK 60 / 600	0,6 - 2,8	198 801 311	
SK 61 / 610	1,4 - 5,6	198 801 312	
SK 62 / 620	1,5 - 7,0	198 801 313	
SK 70 / 700	1,0 - 6,5	198 801 314	
SK 71 / 710	1,5 - 11,0	198 801 315	
SK 72 / 720	3,0 - 18,0	198 801 316	
SK 73 / 730	6,0 - 30,0	198 801 317	

Special scale for short version HCI 30 - 33% l/h

Type	Scale range [l/h]	Code	
SK 50 / 500	2,5 - 20	198 806 511	
SK 51 / 510	5 - 40	198 806 512	
SK 52 / 520	10 - 85	198 806 513	
SK 60 / 600	8 - 70	198 806 514	
SK 61 / 610	15 - 125	198 806 515	
SK 62 / 620	20 - 170	198 806 516	
SK 70 / 700	5 - 125	198 806 517	
SK 71 / 710	30 - 260	198 806 518	
SK 72 / 720	50 - 425	198 806 519	
SK 73 / 730	100 - 850	198 806 520	

Special scale for short version NaOH 30% I/h

Type	Scale range [l/h]	Code	
SK 50 / 500	0.2 - 5	198 806 521	
SK 51 / 510	1 - 14	198 806 522	
SK 52 / 520	3 - 35	198 806 523	
SK 60 / 600	2 - 23	198 806 524	
SK 61 / 610	3 - 55	198 806 525	
SK 62 / 620	5 - 80	198 806 526	
SK 70 / 700	3 - 55	198 806 527	
SK 71 / 710	6 - 130	198 806 528	
SK 72 / 720	10 - 250	198 806 529	
SK 73 / 730	40 - 590	198 806 530	

Special scale for short version NaOH 50% I/h

Type	Scale range [l/h]	Code	
SK 60 / 600	0,2 - 3,5	198 806 531	
SK 61 / 610	0,5 - 10	198 806 532	
SK 62 / 620	0,5 - 16	198 806 533	
SK 70 / 700	0,5 - 11	198 806 534	
SK 71 / 710	1 - 33	198 806 535	
SK 72 / 720	2 - 80	198 806 536	
SK 73 / 730	10 - 220	198 806 537	

Spare Parts for Type 335/350

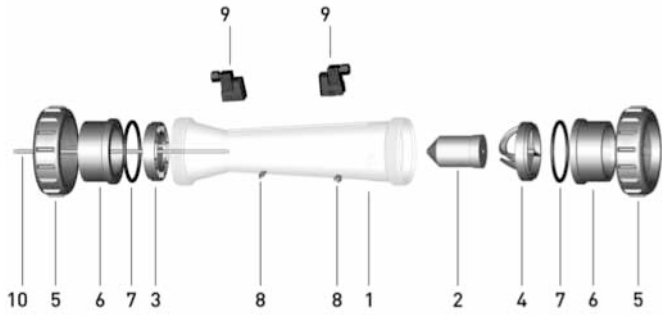

Pos.	Item	Quantity
1	Taper tube	1
2	Float	1
3	Bottom insert	1
4	Top insert	1
5	Union nut	2
6	Union end	2
7	O-Ring	2
8	Flow value indicator	2
9*	Limit contact	2
10**	Guiding rod	1

* optional

** only for DN50 (1500-15000 l/h) and DN65
(all metering ranges)

Variable area flow meter type 335

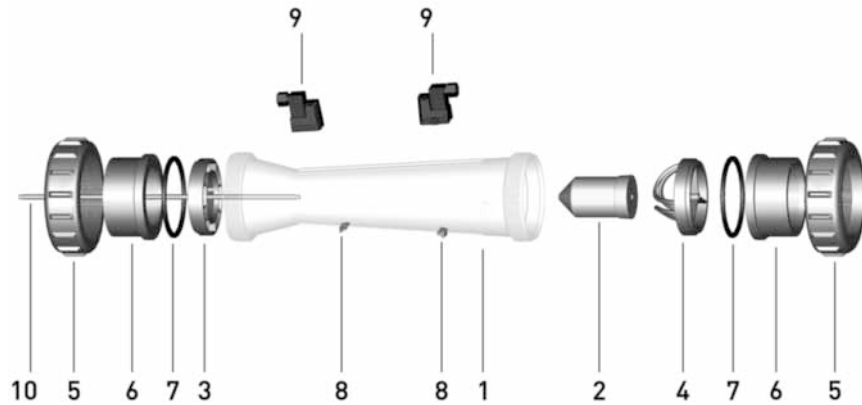

Taper tube with water scale (1)

- * PVC-U transparent >DN40 available from Sept. 2009



Scale range [l/h]	d [mm]	Inch	DN [mm]	PVC-U transparent Code	Polyamid Code	Polysulfon Code
50 - 500	32	1	25	198 335 055	198 335 070	198 335 085
100 - 1000	32	1	25	198 335 056	198 335 071	198 335 086
150 - 1500	40	1 ¼	32	198 335 057	198 335 072	198 335 087
250 - 2500	40	1 ¼	32	198 335 058	198 335 073	198 335 088
200 - 2000	50	1 ½	40	198 335 059	198 335 074	198 335 089
300 - 3000	50	1 ½	40	198 335 060	198 335 075	198 335 090
600 - 6000	50	1 ½	40	198 335 061	198 335 076	198 335 091
600 - 6000	63	2	50	198335062*	198 335 077	198 335 092
1000 - 10000	63	2	50	198335063*	198 335 078	198 335 093
1500 - 15000	63	2	50	198335064*	198 335 079	198 335 094
2000 - 20000	75	2 ½	65	198335065*	198 335 080	198 335 095
3000 - 30000	75	2 ½	65	198335066*	198 335 081	198 335 096
8000 - 60000	75	2 ½	65	198335067*	198 335 082	198 335 097

Taper tube without scale (1)

- * PVC-U transparent >DN40 available from Sept. 2009



Scale range [l/h]	d [mm]	Inch	DN [mm]	PVC-U transparent Code	Polyamid Code	Polysulfon Code
50 - 500	32	1	25	198 335 255	198 335 270	198 335 285
100 - 1000	32	1	25	198 335 256	198 335 271	198 335 286
150 - 1500	40	1 ¼	32	198 335 257	198 335 272	198 335 287
250 - 2500	40	1 ¼	32	198 335 258	198 335 273	198 335 288
200 - 2000	50	1 ½	40	198 335 259	198 335 274	198 335 289
300 - 3000	50	1 ½	40	198 335 260	198 335 275	198 335 290
600 - 6000	50	1 ½	40	198 335 261	198 335 276	198 335 291
600 - 6000	63	2	50	198335262*	198 335 277	198 335 292
1000 - 10000	63	2	50	198335263*	198 335 278	198 335 293
1500 - 15000	63	2	50	198335264*	198 335 279	198 335 294
2000 - 20000	75	2 ½	65	198335265*	198 335 280	198 335 295
3000 - 30000	75	2 ½	65	198335266*	198 335 281	198 335 296
8000 - 60000	75	2 ½	65	198335267*	198 335 282	198 335 297

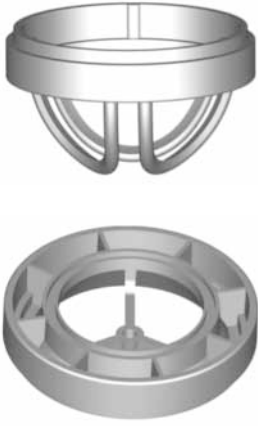

Insert PVDF (3,4)

Scale range [l/h]	d [mm]	Inch	DN [mm]	top (4) Code	bottom (3) Code
50 - 500	32	1	25	198 335 970	198 335 977
100 - 1000	32	1	25	198 335 970	198 335 977
150 - 1500	40	1 ¼	32	198 335 971	198 335 978
250 - 2500	40	1 ¼	32	198 335 971	198 335 978
200 - 2000	50	1 ½	40	198 335 972	198 335 979
300 - 3000	50	1 ½	40	198 335 972	198 335 979
600 - 6000	50	1 ½	40	198 335 972	198 335 979
600 - 6000	63	2	50	198 335 973	198 335 980
1000 - 10000	63	2	50	198 335 973	198 335 980
1500 - 15000	63	2	50	198 335 974	198 335 982
2000 - 20000	75	2 ½	65	198 335 975	198 335 981
3000 - 30000	75	2 ½	65	198 335 975	198 335 981
8000 - 60000	75	2 ½	65	198 335 975	198 335 981



Float PVDF (2)

Scale range [l/h]	d [mm]	Inch	DN [mm]	Without magnet Code	With magnet (bistabil) Code
50 - 500	32	1	25	198 335 455	198 335 470
100 - 1000	32	1	25	198 335 455	198 335 470
150 - 1500	40	1 ¼	32	198 335 455	198 335 470
250 - 2500	40	1 ¼	32	198 335 455	198 335 470
200 - 2000	50	1 ½	40	198 335 456	198 335 471
300 - 3000	50	1 ½	40	198 335 457	198 335 471
600 - 6000	50	1 ½	40	198 335 457	198 335 471
600 - 6000	63	2	50	198 335 457	198 335 471
1000 - 10000	63	2	50	198 335 457	198 335 471
1500 - 15000	63	2	50	198 335 458	198 335 472
2000 - 20000	75	2 ½	65	198 335 459	198 335 473
3000 - 30000	75	2 ½	65	198 335 459	198 335 473
8000 - 60000	75	2 ½	65	198 335 460	198 335 474



Guiding rod PEEK (10)

Model:

- Only for DN50 (1'500 - 15'000 l/h) and DN65 (all metering ranges)

Scale range [l/h]	d [mm]	Inch	DN [mm]	Guiding rod Code
1500 - 15000	63	2	50	198 335 985
2000 - 20000	75	2 ½	65	198 335 985
3000 - 30000	75	2 ½	65	198 335 985
8000 - 80000	75	2 ½	65	198 335 985



Insert guiding rod PVDF (for 10)

Model:

- Only for DN50 (1'500 - 15'000 l/h) and DN65 (all metering ranges)

Scale range [l/h]	d [mm]	Inch	DN [mm]	Insert guiding rod Code
1500 - 15000	63	2	50	198 335 986
2000 - 20000	75	2 ½	65	198 335 987
3000 - 30000	75	2 ½	65	198 335 987
8000 - 80000	75	2 ½	65	198 335 987

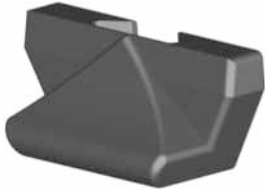

Flow value indicator PS (8)

Model:

- For all dimensions type 335/350

d [mm]	Inch	DN [mm]	Flow value indicator Code	
32	1	25	198 335 990	
40	1 ¼	32	198 335 990	
50	1 ½	40	198 335 990	
63	2	50	198 335 990	
75	2 ½	65	198 335 990	

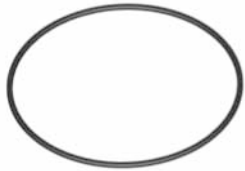

O-rings (7)

d [mm]	Inch	DN [mm]	EPDM Code	FPM Code	
32	1	25	748 410 008	749 410 008	
40	1 ¼	32	748 410 009	749 410 009	
50	1 ½	40	748 410 010	749 410 010	
63	2	50	748 410 011	749 410 011	
75	2 ½	65	748 410 014	749 410 014	



Union nut (5)

PVDF union nut not useable for the special version with taper tube in PVDF

d [mm]	Inch	DN [mm]	PVC-U Code	PVC-C Code	ABS Code	PP-H Code	PVDF Code	
32	1	25	721 690 008	723 690 008	729 690 408	727 690 408	735 690 408	
40	1 ¼	32	721 690 009	723 690 009	729 690 409	727 690 409	735 690 409	
50	1 ½	40	721 690 010	723 690 010	729 690 410	727 690 410	735 690 410	
63	2	50	721 690 011	723 690 011	729 690 411	727 690 411	735 690 411	
75	2 ½	65	198 806 423	-	-	198 806 421	198 806 422	



Union end / Socket (6)

d [mm]	Inch	DN [mm]	PVC-U Code	PVC-C Code	ABS Code	PP-H Code	PVDF Code	
32	1	25	721 600 108	723 600 108	729 600 108	727 600 108	735 600 108	
40	1 ¼	32	721 600 109	723 600 109	729 600 109	727 600 109	735 600 109	
50	1 ½	40	721 600 110	723 600 110	729 600 110	727 600 110	735 600 110	
63	2	50	721 600 111	723 600 111	729 600 111	727 600 111	735 600 111	
75	2 ½	65	721 600 112	723 600 112	729 600 162	700 253 866	-	

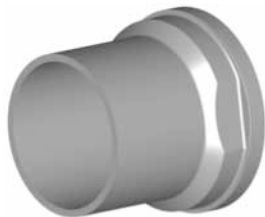

Union end / Spigot (6)

d [mm]	Inch	DN [mm]	PP-H Code	PVDF Code	
32	1	25	727 608 508	735 608 608	
40	1 ¼	32	727 608 509	735 608 609	
50	1 ½	40	727 608 510	735 608 610	
63	2	50	727 608 511	735 608 611	
75	2 ½	65	700 256 401	175 483 013	

Variable area flow meter type 350

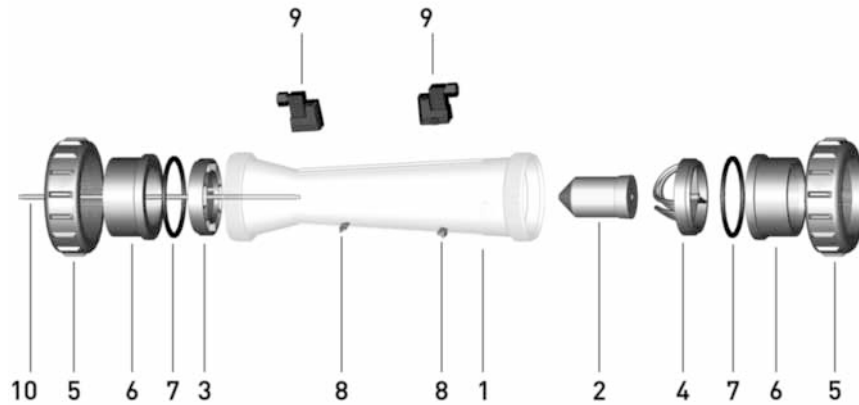

Taper tube with water scale (1)

- * PVC-U transparent >DN40 available from Sept. 2009



Scale range [l/h]	d [mm]	Inch	DN [mm]	PVC-U transparent Code	Polyamid Code	Polysulfon Code
50 - 500	32	1	25	198 350 055	198 350 070	198 350 085
100 - 1000	32	1	25	198 350 056	198 350 071	198 350 086
150 - 1500	40	1 ¼	32	198 350 057	198 350 072	198 350 087
250 - 2500	40	1 ¼	32	198 350 058	198 350 073	198 350 088
200 - 2000	50	1 ½	40	198 350 059	198 350 074	198 350 089
300 - 3000	50	1 ½	40	198 350 060	198 350 075	198 350 090
600 - 6000	50	1 ½	40	198 350 061	198 350 076	198 350 091
600 - 6000	63	2	50	198350062*	198 350 077	198 350 092
1000 - 10000	63	2	50	198350063*	198 350 078	198 350 093
1500 - 15000	63	2	50	198350064*	198 350 079	198 350 094
2000 - 20000	75	2 ½	65	198350065*	198 350 080	198 350 095
3000 - 30000	75	2 ½	65	198350066*	198 350 081	198 350 096
8000 - 60000	75	2 ½	65	198350067*	198 350 082	198 350 097

Taper tube without scale (1)

- * PVC-U transparent >DN40 available from Sept. 2009



Scale range [l/h]	d [mm]	Inch	DN [mm]	PVC-U transparent Code	Polyamid Code	Polysulfon Code
50 - 500	32	1	25	198 350 255	198 350 270	198 350 285
100 - 1000	32	1	25	198 350 256	198 350 271	198 350 286
150 - 1500	40	1 ¼	32	198 350 257	198 350 272	198 350 287
250 - 2500	40	1 ¼	32	198 350 258	198 350 273	198 350 288
200 - 2000	50	1 ½	40	198 350 259	198 350 274	198 350 289
300 - 3000	50	1 ½	40	198 350 260	198 350 275	198 350 290
600 - 6000	50	1 ½	40	198 350 261	198 350 276	198 350 291
600 - 6000	63	2	50	198350262*	198 350 277	198 350 292
1000 - 10000	63	2	50	198350263*	198 350 278	198 350 293
1500 - 15000	63	2	50	198350264*	198 350 279	198 350 294
2000 - 20000	75	2 ½	65	198350265*	198 350 280	198 350 295
3000 - 30000	75	2 ½	65	198350266*	198 350 281	198 350 296
8000 - 60000	75	2 ½	65	198350267*	198 350 282	198 350 297

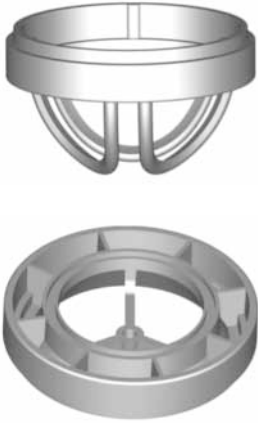

Insert PVDF (3,4)

Scale range [l/h]	d [mm]	Inch	DN [mm]	top (4) Code	bottom (3) Code
50 - 500	32	1	25	198 335 970	198 335 977
100 - 1000	32	1	25	198 335 970	198 335 977
150 - 1500	40	1 ¼	32	198 335 971	198 335 978
250 - 2500	40	1 ¼	32	198 335 971	198 335 978
200 - 2000	50	1 ½	40	198 335 972	198 335 979
300 - 3000	50	1 ½	40	198 335 972	198 335 979
600 - 6000	50	1 ½	40	198 335 972	198 335 979
600 - 6000	63	2	50	198 335 973	198 335 980
1000 - 10000	63	2	50	198 335 973	198 335 980
1500 - 15000	63	2	50	198 335 974	198 335 982
2000 - 20000	75	2 ½	65	198 335 975	198 335 981
3000 - 30000	75	2 ½	65	198 335 975	198 335 981
8000 - 60000	75	2 ½	65	198 335 975	198 335 981



Float PVDF (2)

Scale range [l/h]	d [mm]	Inch	DN [mm]	Without magnet Code	With magnet Code
50 - 500	32	1	25	198 335 455	198 335 470
100 - 1000	32	1	25	198 335 455	198 335 470
150 - 1500	40	1 ¼	32	198 335 455	198 335 470
250 - 2500	40	1 ¼	32	198 335 455	198 335 470
200 - 2000	50	1 ½	40	198 335 456	198 335 471
300 - 3000	50	1 ½	40	198 335 457	198 335 471
600 - 6000	50	1 ½	40	198 335 457	198 335 471
600 - 6000	63	2	50	198 335 457	198 335 471
1000 - 10000	63	2	50	198 335 457	198 335 471
1500 - 15000	63	2	50	198 335 458	198 335 472
2000 - 20000	75	2 ½	65	198 335 459	198 335 473
3000 - 30000	75	2 ½	65	198 335 459	198 335 473
8000 - 60000	75	2 ½	65	198 335 460	198 335 474



Guiding rod PEEK (10)

Model:

- Only for DN50 (1'500 - 15'000 l/h) and DN65 (all metering ranges)

Scale range [l/h]	d [mm]	Inch	DN [mm]	Guiding rod Code
1500 - 15000	63	2	50	198 350 980
2000 - 20000	75	2 ½	65	198 350 980
3000 - 30000	75	2 ½	65	198 350 980
8000 - 60000	75	2 ½	65	198 350 980



Insert guiding rod PVDF (for 10)

Model:

- Only for DN50 (1'500 - 15'000 l/h) and DN65 (all metering ranges)

Scale range [l/h]	d [mm]	Inch	DN [mm]	Insert guiding rod Code
1500 - 15000	63	2	50	198 335 986
2000 - 20000	75	2 ½	65	198 335 987
3000 - 30000	75	2 ½	65	198 335 987
8000 - 60000	75	2 ½	65	198 335 987

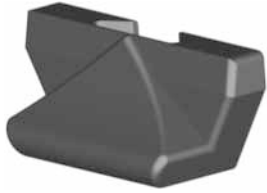

Flow value indicator PS (8)

Model:

- For all dimensions type 335/350

d [mm]	Inch	DN [mm]	Flow value indicator Code
32	1	25	198 335 990
40	1 ¼	32	198 335 990
50	1 ½	40	198 335 990
63	2	50	198 335 990
75	2 ½	65	198 335 990

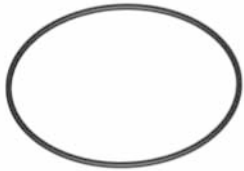

O-rings (7)

d [mm]	Inch	DN [mm]	EPDM Code	FPM Code
32	1	25	748 410 008	749 410 008
40	1 ¼	32	748 410 009	749 410 009
50	1 ½	40	748 410 010	749 410 010
63	2	50	748 410 011	749 410 011
75	2 ½	65	748 410 014	749 410 014



Union nut (5)

PVDF union nut not useable for the special version with taper tube in PVDF

d [mm]	Inch	DN [mm]	PVC-U Code	PVC-C Code	ABS Code	PP-H Code	PVDF Code
32	1	25	721 690 008	723 690 008	729 690 408	727 690 408	735 690 408
40	1 ¼	32	721 690 009	723 690 009	729 690 409	727 690 409	735 690 409
50	1 ½	40	721 690 010	723 690 010	729 690 410	727 690 410	735 690 410
63	2	50	721 690 011	723 690 011	729 690 411	727 690 411	735 690 411
75	2 ½	65	198 806 423	-	-	198 806 421	198 806 422



Union end / Socket (6)

d [mm]	Inch	DN [mm]	PVC-U Code	PVC-C Code	ABS Code	PP-H Code	PVDF Code
32	1	25	721 600 108	723 600 108	729 600 108	727 600 108	735 600 108
40	1 ¼	32	721 600 109	723 600 109	729 600 109	727 600 109	735 600 109
50	1 ½	40	721 600 110	723 600 110	729 600 110	727 600 110	735 600 110
63	2	50	721 600 111	723 600 111	729 600 111	727 600 111	735 600 111
75	2 ½	65	721 600 112	723 600 112	729 600 162	700 253 866	-

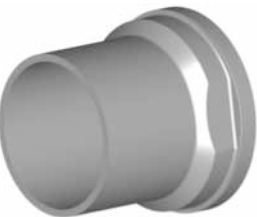

Union end / Spigot (6)

d [mm]	Inch	DN [mm]	PP-H Code	PVDF Code
32	1	25	727 608 508	735 608 608
40	1 ¼	32	727 608 509	735 608 609
50	1 ½	40	727 608 510	735 608 610
63	2	50	727 608 511	735 608 611
75	2 ½	65	700 256 401	175 483 013

Technical information for type SK

Pos.	Item	Quantity
1	Taper tube	1
2	Float	1
3	Bottom insert	1
4	Top insert	1
5	Union nut	2
6	Union end	2
7	O-Ring	2
8	Flow value indicator	2

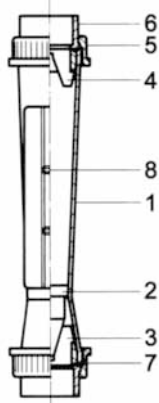

Pressure loss for type SK

Type	Loss (mm Wp)
SK 10/100	242
SK 11/110	242
SK 12/120	242
SK 18/180	255
SK 19/190	255
SK 20/200	255
SK 21/210	255
SK 29/290	254
SK 30/300	305
SK 31/310	305

Type	Loss (mm Wp)
SK 40/400	312
SK 41/410	312
SK 50/500	44
SK 51/510	44
SK 52/520	44

Type	Loss (mm Wp)
SK 60/600	83
SK 61/610	83
SK 62/620	83
SK 70/700	46
SK 71/710	46
SK 72/720	46
SK 73/730	46

**Spare part for variable area flow meter
SK50-SK73/SK500-SK730
Short version taper tube Polysulfone**

Type	d [mm]	DN [mm]	Code
SK 50 / 500	16	10	198 801 341
SK 51 / 510	16	10	198 801 342
SK 52 / 520	16	10	198 801 343
SK 60 / 600	20	15	198 801 449
SK 61 / 610	20	15	198 801 450
SK 62 / 620	20	15	198 801 451
SK 70 / 700	32	25	198 801 445
SK 71 / 710	32	25	198 801 338
SK 72 / 720	32	25	198 801 339
SK 73 / 730	32	25	198 801 340

**Spare part for variable area flow meter
SK50-SK73/SK500-SK730
Short version taper tube PVC-U transparent**

Type	d [mm]	DN [mm]	Code
SK 50 / 500	16	10	198 803 790
SK 51 / 510	16	10	198 803 791
SK 52 / 520	16	10	198 803 792
SK 60 / 600	20	15	198 803 793
SK 61 / 610	20	15	198 803 794
SK 62 / 620	20	15	198 803 795
SK 70 / 700	32	25	198 803 796
SK 71 / 710	32	25	198 803 797
SK 72 / 720	32	25	198 803 798
SK 73 / 730	32	25	198 803 799

**Spare part for variable area flow meter
SK50-SK73/SK500-SK730
Short version float PVDF
Without magnet**

Type	d [mm]	DN [mm]	Code
SK 50 / 51 / 52	16	10	198 806 219
SK 60 / 61 / 62	20	15	198 806 220
SK 70 / 71 / 72 / 73	32	25	198 806 221

**Spare part for variable area flow meter
SK50-SK73/SK500-SK730
Short version float PVDF
With magnet bistable**

Type	d [mm]	DN [mm]	Code
SK 500 / 510 / 520	16	10	198 806 222
SK 600 / 610 / 620	20	15	198 806 223
SK 700 / 710 / 720 / 730	32	25	198 806 224

**Spare part for variable area flow meter
SK50-SK73/SK500-SK730
Short version float PTFE
Without magnet**

Type	d [mm]	DN [mm]	Code
SK 73	32	25	198 807 166

**Spare part for variable area flow meter
SK50-SK73/SK500-SK730
Short version top insert PVDF**

Type	d [mm]	DN [mm]	Code
SK 50 / 500; 51 / 510; 52 / 520	16	10	198 807 188
SK 60 / 600; 61 / 610; 62 / 620	20	15	198 807 187
SK 70 / 700; 71 / 710; 72 / 720; 73 / 730	32	25	198 807 182

**Spare part for variable area flow meter
SK10-SK41/SK100-SK410
Standard version float PTFE
Without magnet**

Type	d [mm]	DN [mm]	Code
SK 20	50	40	198 807 167
SK 21	50	40	198 807 171
SK 30	63	50	198 807 168
SK 31	63	50	198 807 172
SK 40	75	65	198 807 169
SK 41	75	65	198 807 170

Adjustment Factors

Temperature-adjustment table for gases

		Calibrating temperature (°C)								
		0	10	20	30	40	50	60	70	80
Operating temperature (°C)	0	1	1.018	1.035	1.052	1.07	1.088	1.103	1.12	1.135
	10	0.983	1	1.018	1.035	1.051	1.068	1.084	1.1	1.116
	20	0.965	0.983	1	1.015	1.032	1.05	1.065	1.08	1.096
	30	0.948	0.966	0.983	1	1.015	1.031	1.047	1.062	1.08
	40	0.933	0.95	0.967	0.984	1	1.015	1.031	1.046	1.061
	50	0.92	0.936	0.953	0.968	0.984	1	1.015	1.03	1.045
	60	0.905	0.922	0.938	0.953	0.968	0.985	1	1.015	1.03
	70	0.892	0.907	0.924	0.94	0.955	0.97	0.985	1	1.014
	80	0.88	0.895	0.912	0.927	0.943	0.965	0.971	0.987	1

Use this chart to adjust the displayed values for gaseous media of your flow meter, if the operating temperature differs from the underlying temperature (20°C) at calibrating time.

Example:

Calibrating temperature is 20°C and operating temperature is 70°C. Take the factor 0.924 from the calibrating temperature column for 20°C and the operating temperature line 70°C. The values shown by the flow meter have to be multiplied by this factor so the actual flow volume at an operating temperature of 70°C can be calculated. You get the factor with the following formula:

$$\sqrt{\frac{T_c + 237}{T_o + 237}} = \sqrt{\frac{20 + 237}{70 + 237}} = 0.924$$

T_c = calibrating temperature

T_o = operating temperature

Note:

Operating temperature > calibrating temperature:

Factor < 1

Operating temperature < calibrating temperature:

Factor > 1

Density-adjustment table for gases

		Gases for calibration					
operating gasses	P [kg/Nm ³]	air	oxygen	nitrogen	ammonia	acetylene	chlorine
air	1.293	1.000	1.050	0.983	0.772	0.953	1.580
oxygen	1.429	0.953	1.000	0.935	0.735	0.906	1.500
nitrogen	1.251	1.017	1.069	1.000	0.786	0.968	1.604
ammonia	0.771	1.295	1.360	1.272	1.000	1.232	2.040
acetylene	1.171	1.050	1.105	1.033	0.812	1.000	1.660
chlorine	3.220	0.633	0.665	0.623	0.490	0.603	1.000
hydrogen	0.089	3.810	4.010	3.750	2.940	3.630	6.020
carbon dioxide	1.977	0.808	0.850	0.796	0.625	0.770	1.275
sulphur dioxide	2.926	0.668	0.698	0.654	0.514	0.633	1.050
coal gas	0.550	1.532	1.610	1.506	1.185	1.460	2.420
propane	2.020	0.800	0.841	0.786	0.618	0.762	1.262

		Gases for calibration				
operating gasses	P [kg/Nm ³]	hydrogen	carbon dioxide	sulphur dioxide	coal gas	propane
air	1.293	0.262	1.238	1.495	0.652	1.250
oxygen	1.429	0.250	1.175	1.430	0.621	1.189
nitrogen	1.251	0.267	1.255	1.530	0.664	1.272
ammonia	0.771	0.340	1.600	1.946	0.845	1.620
acetylene	1.171	0.276	1.300	1.580	0.685	1.314
chlorine	3.220	0.166	0.785	0.953	0.413	0.792
hydrogen	0.089	1.000	4.715	5.725	2.480	4.760
carbon dioxide	1.977	0.212	1.000	1.216	0.528	1.010
sulphur dioxide	2.926	0.174	0.823	1.000	0.433	0.830
coal gas	0.550	0.403	1.895	2.306	1.000	1.915
propane	2.020	0.210	0.990	1.205	0.522	1.000

Use this chart to adjust the displayed values for gaseous media of your flow meter, if the specific media gravity differs from the underlying specific gravity (1.293 kg/Nm³ (air)) at calibrating time.

Example:

Specific gravity at calibrating time is 1.293 kg/Nm³ (air). The media hydrogen with its specific gravity of 0.089 kg/Nm³ should be measured. From the column hydrogen, in line seven for operating gas, you get the factor 3.81. The values shown by the flow meter have to be multiplied by this factor so the actual flow volume at a specific gravity of 0.089 kg/Nm³ can be calculated.

Note:

Operating gas density > calibrating gas density:

Factor < 1

Operating gas density < calibrating gas density:

Factor > 1

Density-adjustment table for liquids

		Calibrating solution (kg/l) float material PVDF							
		0.5	0.6	0.7	0.8	0.9	1	1.1	1.2
Density of operating liquid	0.5	1	1.105	1.2	1.29	1.38	1.464	1.545	1.63
	0.6	0.903	1	1.084	1.168	1.248	1.32	1.397	1.475
	0.7	0.834	0.923	1	1.078	1.15	1.22	1.29	1.36
	0.8	0.775	0.856	0.928	1	1.066	1.133	1.196	1.262
	0.9	0.724	0.802	0.87	0.937	1	1.06	1.12	1.18
	1.0	0.683	0.755	0.818	0.883	0.94	1	1.055	1.114
	1.1	0.645	0.715	0.771	0.836	0.892	0.946	1	1.055
	1.2	0.613	0.678	0.735	0.793	0.845	0.896	0.947	1
	1.3	0.585	0.648	0.7	0.755	0.807	0.857	0.903	0.955
	1.4	0.56	0.62	0.671	0.723	0.773	0.82	0.865	0.913
	1.5	0.537	0.595	0.645	0.695	0.743	0.787	0.832	0.877
	1.6	0.515	0.57	0.618	0.665	0.712	0.755	0.798	0.84
	1.7	0.496	0.548	0.595	0.641	0.685	0.726	0.767	0.81
	1.8	0.478	0.538	0.574	0.617	0.66	0.7	0.74	0.78
1.9	0.462	0.511	0.555	0.597	0.638	0.676	0.715	0.755	
2.0	0.446	0.495	0.536	0.578	0.617	0.654	0.691	0.73	

		Calibrating solution (kg/l) float material PVDF							
		1.3	1.4	1.5	1.6	1.7	1.8	1.9	2
Density of operating liquid	0.5	1.71	1.785	1.86	0.94	2.02	2.09	2.16	2.24
	0.6	1.545	1.615	1.68	0.754	1.82	1.89	1.95	2.02
	0.7	1.425	1.49	1.55	1.615	1.68	1.745	1.8	1.865
	0.8	1.325	1.38	1.43	1.5	1.56	1.62	1.67	1.73
	0.9	1.24	1.295	1.35	1.405	1.46	1.515	1.57	1.62
	1.0	1.17	1.22	1.27	1.325	1.375	1.43	1.48	1.53
	1.1	1.106	1.155	1.2	1.255	1.3	1.35	1.4	1.45
	1.2	1.05	1.095	1.14	1.19	1.235	1.28	1.33	1.37
	1.3	1	1.044	1.088	1.134	1.176	1.22	1.264	1.305
	1.4	0.958	1	1.042	1.085	1.13	1.17	1.21	1.25
	1.5	0.92	0.96	1	1.042	1.084	1.125	1.16	1.205
	1.6	0.882	0.92	0.958	1	1.04	1.08	1.11	1.15
	1.7	0.848	0.886	0.923	0.961	1	1.038	1.072	1.11
	1.8	0.817	0.853	0.888	0.926	0.962	1	1.032	1.07
1.9	0.79	0.826	0.858	0.897	0.93	0.968	1	1.034	
2.0	0.798	0.798	0.83	0.867	0.9	0.935	0.965	1	

Use this chart to adjust the displayed values for liquid media of your flow meter, if the specific media gravity (1.0 kg/l (water)) differs from the underlying specific gravity at calibrating time.

Example:

Specific gravity at calibration 1.0 kg/l. The liquid media with a specific gravity of 0.9 kg/l is to be measured. If you have a calibrating solution of 1.0 kg/l you take in line five the factor 1.06. The values shown by the flow

meter have to be multiplied by this factor so the actual flow volume at a specific gravity of 0.9 can be calculated.

Note:

New density is higher: factor <1
New density is lower : factor >1

General Condition of Supply of Georg Fischer Piping Systems Limited, Schaffhausen

1 General

- 1.1 These General Conditions shall apply to all Products supplied by Georg Fischer to the Purchaser. They shall also apply to all future business even when no express reference is made to them.
- 1.2 Any deviating or supplementary conditions especially Purchaser's general conditions of purchase and verbal agreements shall only be applicable if accepted in writing by Georg Fischer.
- 1.3 The written form shall be deemed to be fulfilled by all forms of transmission, evidenced in the form of text, such as telefax, e-mail, etc.

2 Tenders

- Tenders shall only be binding if they contain a specifically stated period for acceptance.

3 Scope of Delivery

- 3.1 Georg Fischer's product range is subject to change.
- 3.2 The confirmation of order shall govern the scope and execution of the contract.

4 Data and Documents

- 4.1 Technical documents such as drawings, descriptions, illustrations and data on dimensions, performance and weight as well as the reference to standards are for information purposes only. They are not warranted characteristics and are subject to change.
- 4.2 All technical documents shall remain the exclusive property of Georg Fischer and may only be used for the agreed purposes or as Georg Fischer may consent.

5 Confidentiality, Protection of Personal Data

- 5.1 Each party shall keep in strict confidence all commercial or technical information relating to the business of the other party, of which it has gained knowledge in the course of its dealing with the other party. Such information shall neither be disclosed to third parties nor used for other purposes than those for which the information has been supplied.
- 5.2 In the context of the contractual relation with the Purchaser personal data may be processed. The Purchaser agrees to the disclosure of said data to third parties such as foreign subcontractors and suppliers etc.

6 Local Laws and Regulations, Export Controls

- 6.1 The Purchaser shall bring to the attention of Georg Fischer all local laws and regulations at the place of destination which bear connection with the execution of the contract and the adherence to relevant safety regulations and approval procedures.
- 6.2 In case of re-exports, Purchaser shall be responsible for compliance with pertinent export control regulations.

7 Price

- 7.1 Unless agreed otherwise, the prices shall be deemed quoted net ex works (according to Incoterms of the ICC, latest version) including standard packing. All supplementary costs such as the cost of carriage, insurance, export-, transit- and importlicences etc. shall be borne by the Purchaser. The Purchaser shall also bear the costs of all taxes, fees, duties etc. connected with the contract.
- 7.2 If the costs of packing, carriage, insurance, fees and other supplementary costs are included in the tender price or contract price or are referred to specifically in the tender or confirmation of order, Georg Fischer reserve the right to revise their prices accordingly should any change occur in the relevant tariffs.

8 Terms of Payment

- 8.1 The Purchaser shall make payment in the manner agreed by the parties without any deductions such as discounts, costs, taxes or dues.
- 8.2 The Purchaser may only withhold or off-set payments due against counter claims which are either expressly acknowledged by Georg Fischer or finally awarded to the Purchaser. In particular, payment shall still be made when unessential items are still out-standing provided that the Products already delivered are not rendered unusable as a result.

9 Retention of Title

- 9.1 The Products shall remain the property of Georg Fischer until the Purchaser shall have settled all claims, present and future, which Georg Fischer may have against him.
- 9.2 Should the Purchaser resell Products to which title is reserved, in the ordinary course of business, he shall hereby be deemed to have tacitly assigned to Georg Fischer the proceeds deriving from their sale together with all collateral rights, securities and reservations of title until all claims held by Georg Fischer shall have been settled. Until revoked by Georg Fischer, this assignment shall not preclude Purchaser's right to collect the assigned receivables.
- 9.3 To the extent the value of the Products to which title is reserved together with collateral securities exceeds Georg Fischer's claims against the Purchaser by more than 20%, Georg Fischer shall re-assign the above proceeds to Purchaser at his request.

10 Delivery

- 10.1 The term of delivery shall commence as soon as the contract has been entered into, all official formalities such as import and payment permits have been obtained and all essential technical issues have been settled. The term of delivery shall be deemed duly observed when, upon its expiry, the Products are ready for despatch.
- 10.2 Delivery is subject to the following conditions, i.e. the term of delivery shall be reasonably extended:
 - a) if Georg Fischer are not supplied in time with the information necessary for the execution of the contract or if subsequent changes causing delays are made by the Purchaser.
 - b) if Georg Fischer are prevented from performing the contract by force majeure. Force majeure shall equally be deemed to be any unforeseeable event beyond Georg Fischer's control which renders Georg Fischer's performance commercially unpractical or impossible, such as delayed or defective supplies from sub contractors labour disputes, governmental orders or regulations, shortages in materials or energy, serious disturbances in Georg Fischer's works, such as the total or partial destruction of plant and equipment or the breakdown of essential facilities, serious disruptions in transport facilities, e.g. impassable roads.
Should the effect of force majeure exceed a period of six months, either party may cancel the contract forthwith.
Georg Fischer shall not be liable for any damage or loss of any kind whatsoever resulting therefrom, any suspension or cancellation being without prejudice to Georg Fischer's right to recover all sums due in respect of consignments delivered and costs incurred to date.
 - c) if the Purchaser is in delay with the fulfilment of his obligations under the contract, in particular, if he does not adhere to the agreed conditions of payment or if he has failed to timely provide the agreed securities.
- 10.3 If for reasons attributable to Georg Fischer the agreed term of delivery or a reasonable extension thereof is exceeded, Georg Fischer shall not be deemed in default until the Purchaser has granted to Georg Fischer in writing a reasonable extension thereof of not less than one month which equally is not met.
The Purchaser shall then be entitled to the remedies provided at law, it being however understood that, subject to limitations of Art. 16, damage claims shall be limited to max. 10% of the price of the delayed delivery.
- 10.4 Part shipments shall be allowed and Georg Fischer shall be entitled to invoice for such partial deliveries.
- 10.5 If the Purchaser fails to take delivery within a reasonable time of Products notified as ready for despatch, Georg Fischer shall be entitled to store the Products at the Purchaser's expense and risk and to invoice them as delivered. If Purchaser fails to effect payment, Georg Fischer shall be entitled to dispose of the Products.
- 10.6 Should Purchaser cancel an order without justification and should Georg Fischer not insist on the performance of the contract, Georg Fischer shall be entitled to liquidated damages in the amount of 10% of the contract price, Georg Fischer's right to prove and claim higher damages remaining reserved. Purchaser shall be entitled to prove, that Georg Fischer has suffered no or a considerably lower damage.

11 Packing

- If the Products are provided with additional packing over and above the standard packing, such packing shall be charged additionally.

12 Passing of Risk

- 12.1 The risk in the Products shall pass to the Purchaser as soon as they have left Georg Fischer's works (EX WORKS, Incoterms ICC, latest version), even if delivery is made carriage-paid, under similar clauses or including installation or when carriage is organized and managed by Georg Fischer.
- 12.2 If delivery is delayed for reasons beyond Georg Fischer's control, the risk shall pass to the Purchaser when he is notified that the Products are ready for despatch.

13 Carriage and Insurance

- 13.1 Unless agreed otherwise, the Purchaser shall bear the cost of carriage.
- 13.2 The Purchaser shall be responsible for transport insurance against damage of whatever kind. Even when such insurance is arranged by Georg Fischer it shall be deemed taken out by the order of and for the account of the Purchaser and at his risk.
- 13.3 Special requests regarding carriage and insurance shall be communicated to Georg Fischer in due time. Otherwise carriage shall be arranged by Georg Fischer at their discretion, but without responsibility, by the quickest and cheapest method possible.
In case of carriage-paid delivery transport arrangements shall be made by Georg Fischer. If the Purchaser specifies particular requirements, any extra costs involved shall be borne by him.
- 13.4 In the event of damage or loss of the Products during carriage the Purchaser shall mark the delivery documents accordingly and immediately have the damage ascertained by the carrier. Not readily ascertainable damages sustained during carriage shall be notified to the carrier within six days after receipt of the Products.

14 Inspection, Notification of Defects and Damages

- 14.1 The Products will be subject to normal inspection by Georg Fischer during manufacture. Additional tests required by the Purchaser shall be agreed upon in writing and shall be charged to the Purchaser.
- 14.2 It shall be a condition of Georg Fischer's obligation under the warranties stated hereinafter that Georg Fischer be notified in writing by the Purchaser of any purported defect immediately upon discovery. Notice concerning weight, numbers or apparent defects is to be given latest within 30 days from receipt of the Products, notice of other defects immediately latest within 7 working days after discovery, in any event within the agreed warranty period.
- 14.3 Purchaser shall not dispose of allegedly defective Products until all warranty and/or damage claims are finally settled. At its request, defective Products are to be placed at Georg Fischer's disposal.
- 14.4 At its request, Georg Fischer shall be given the opportunity to inspect the defect and/or damage, prior to commencement of remedial work, either itself or by third party experts.

15 Warranty

- 15.1 At the written request of the Purchaser, Georg Fischer undertake to repair or replace at their discretion, as quickly as possible and free of charge all Products supplied which demonstrably suffer from faulty design, materials or workman-ship or from faulty operating or installation instructions.
In order to protect employees from toxic or radioactive substances which may have been transported through defective parts returned to Georg Fischer's sales organisation, said parts must be accompanied by a Material Safety Disclosure Form. The form may be obtained from Georg Fischer's local sales company or via www.piping.georgfischer.com. Replaced parts shall become property of Georg Fischer.
- 15.2 For Products which are manufactured to specifications, drawings or patterns supplied by the Purchaser, Georg Fischer's warranty shall be restricted to proper materials and workmanship.
- 15.3 The Purchaser shall be entitled to cancel the contract or to demand a reduction in the contract price if also a second attempt to repair or replace the Products has failed.
- 15.4 For Products or essential components manufactured by a third party and supplied by Georg Fischer under this contract, Georg Fischer's warranty is limited to the warranty provided by said third party.
- 15.5 This warranty shall not apply to damage resulting from normal wear and tear, improper storage and maintenance, failure to observe the operating instructions, overloading, unsuitable operating media, unsuitable construction work or unsuitable building ground, improper repairs or alterations by the Purchaser or third parties, the use of other than original spare parts and other reasons beyond Georg Fischer's control.
- 15.6 No action or claim may be brought by the Purchaser on account of any alleged breach of warranty or any other obligation of Georg Fischer after the expiration of twelve (12) months from receipt of the Products by the end user or at the latest within eighteen (18) months of the Products being despatched by Georg Fischer.
- 15.7 In case of Products for use in domestic installations or in utilities
 - Georg Fischer will assume the costs of dismantling the defective Product and restoring the damaged object as well as, in case of negligence, all other direct damages caused by the defective Product (damage to property and injury to or death of persons) up to CHF 1 000 000 per occurrence.
 - the statute of limitations for warranty or damage claims - contrary to Section 15.6 - will be 5 years from the date of installation.

16 Limitation of Liability

- All cases of breach of contract and the relevant consequences as well as all rights and claims on the part of the customer, irrespective on what ground they are based, are exhaustively covered by these general conditions of supply. In particular, any claims not expressly mentioned for damages, reduction of price, termination of or withdrawal from the contract are excluded. In no case whatsoever shall the customer be entitled to claim damages other than compensation for costs of remedying defects in the supplies. This in particular refers, but shall not be limited, to loss of production, loss of use, loss of orders, loss of profit and other direct or indirect or consequential damage. This exclusion of liability, however, does not apply to unlawful intent or gross negligence on the part of Georg Fischer and in case of strict liability under applicable product liability statutes, but does apply to unlawful intent or gross negligence of persons employed or appointed by Georg Fischer to perform any of its obligations.

17 Severability

- Should any term or clause of these General Conditions in whole or in part be found to be unenforceable or void, all other provisions shall remain in full force and effect and the unenforceable or void provision shall be replaced by a valid provision, which comes closest to the original intention of the unenforceable or invalid provision.

18 Place of Performance and Jurisdiction

- 18.1 Place of performance for the Products shall be the Georg Fischer works from which the Products are despatched.
- 18.2 Any civil action based upon any alleged breach of this contract shall be filed and prosecuted exclusively in the courts of Schaffhausen, Switzerland.
Georg Fischer however reserves the right to file actions in any court having jurisdiction over controversies arising out of or in connection with the present contract.
- 18.3 The contract shall be governed by Swiss law without regard to conflict of law provisions that would require the application of another law.

GF Piping Systems → worldwide at home

Our sales companies and representatives ensure local customer support in over 100 countries.

www.piping.georgfischer.com



The technical data are not binding. They constitute neither expressly warranted characteristics nor guaranteed properties nor a guaranteed durability. They are subject to modification. Our General Terms of Sale apply.

Adding Quality to People's Lives

Australia

George Fischer Pty Ltd
Riverwood NSW 2210 Australia
Phone +61(0)2 9502 8000
australia.ps@georgfischer.com
www.georgfischer.com.au

Austria

Georg Fischer
Rohrleitungssysteme GmbH
3130 Herzogenburg
Phone +43(0)2782 856 43-0
austria.ps@georgfischer.com
www.georgfischer.at

Belgium / Luxembourg

Georg Fischer NV/SA
1070 Bruxelles/Brüssel
Phone +32(0)2 556 40 20
be.ps@georgfischer.com
www.georgfischer.be

Brazil

George Fischer Ltda
04795-100 São Paulo
Phone +55(0)11 5687 1311
br.ps@georgfischer.com

China

Georg Fischer
Piping Systems Ltd Shanghai
Pudong, Shanghai 201319
Phone +86(0)21 58 13 33 33
china.ps@georgfischer.com
www.cn.piping.georgfischer.com

Denmark / Iceland

Georg Fischer A/S
2630 Taastrup
Phone +45 (0)70 22 19 75
info.dk.ps@georgfischer.com
www.georgfischer.dk

France

Georg Fischer SAS
95932 Roissy Charles de Gaulle Cedex
Phone +33(0)1 41 84 68 84
fr.ps@georgfischer.com
www.georgfischer.fr

Germany

Georg Fischer GmbH
73095 Albershausen
Phone +49(0)7161 302-0
info.de.ps@georgfischer.com
www.georgfischer.de

India

Georg Fischer Piping Systems Ltd
400 076 Mumbai
Phone +91 224007 2001
in.ps@georgfischer.com
www.georgfischer.in

Italy

Georg Fischer S.p.A.
20063 Cernusco S/N (MI)
Phone +3902 921 861
it.ps@georgfischer.com
www.georgfischer.it

Japan

Georg Fischer Ltd
556-0011 Osaka,
Phone +81(0)6 6635 2691
jp.ps@georgfischer.com
www.georgfischer.jp

Korea

Georg Fischer Piping Systems
Guro-3 dong, Guro-gu, Seoul, Korea
Phone +82(0)2 2081 1450
Fax +82(0)2 2081 1453
kor.ps@georgfischer.com

Malaysia

Georg Fischer (M) Sdn. Bhd.
40460 Shah Alam, Selangor
Phone +60 (0)3 5122 5585
conne.kong@georgfischer.com

Mexico

Georg Fischer S.A. de C.V.
Apodaca, Nuevo Leon
CP66636 Mexico
Phone +52 (81)1340 8586
Fax +52 (81)1522 8906

Middle East

Georg Fischer Piping Systems
Dubai, United Arab Emirates
Phone +971 4 289 49 60
info.export@georgfischer.com
www.export.georgfischer.com

Netherlands

Georg Fischer N.V.
8161 PA Epe
Phone +31(0)578 678 222
nl.ps@georgfischer.com
www.georgfischer.nl

Norway

Georg Fischer AS
1351 Rud
Phone +47(0)67 18 29 00
no.ps@georgfischer.com
www.georgfischer.no

Poland

Georg Fischer Sp. z o.o.
02-226 Warszawa
Phone +48(0)22 313 10 50
poland.ps@georgfischer.com
www.georgfischer.pl

Romania

Georg Fischer
Piping Systems Ltd
020257 Bucharest - Sector 2
Phone +40(0)21 230 53 80
ro.ps@georgfischer.com
www.export.georgfischer.com

Russia

Georg Fischer Piping Systems
Moscow 125047
Tel. +7 495 258 60 80
ru.ps@georgfischer.com
www.georgfischer.ru

Singapore

George Fischer Pte Ltd
528 872 Singapore
Phone +65(0)67 47 06 11
sgp.ps@georgfischer.com
www.georgfischer.com.sg

Spain / Portugal

Georg Fischer S.A.
28046 Madrid
Phone +34(0)91 781 98 90
es.ps@georgfischer.com
www.georgfischer.es

Sweden / Finland

Georg Fischer AB
12523 Älvsjö-Stockholm
Phone +46(0)8 506 775 00
info.se.ps@georgfischer.com
www.georgfischer.se

Switzerland

Georg Fischer
Rohrleitungssysteme (Schweiz) AG
8201 Schaffhausen
Phone +41(0)52 631 30 26
ch.ps@georgfischer.com
www.piping.georgfischer.ch

Taiwan

Georg Fischer Piping Systems
San Chung City, Taipei Hsien
Phone +886 2 8512 2822
Fax +886 2 8512 2823

United Kingdom / Ireland

Georg Fischer Sales Limited
Coventry, CV2 2ST
Phone +44(0)2476 535 535
uk.ps@georgfischer.com
www.georgfischer.co.uk

USA / Canada / Latin America / Caribbean

Georg Fischer LLC
Tustin, CA 92780-7258
Phone +1(714) 731 88 00
Toll Free 800 854 40 90
us.ps@georgfischer.com
www.us.piping.georgfischer.com

International

Georg Fischer
Piping Systems (Switzerland) Ltd.
8201 Schaffhausen
Phone +41(0)52 631 30 03
Fax +41(0)52 631 28 93
info.export@georgfischer.com
www.export.georgfischer.com

GFDO_6168_4 (03.09)

© Georg Fischer Piping Systems Ltd.
8201 Schaffhausen/Switzerland, 2009
Printed in Switzerland

+GF+

GEORG FISCHER
PIPING SYSTEMS